

Pipet Tips

1

Standard & Gel Loading

Volume: 1-200µl

For use with but not limited to:

Pipetman®
 Biohit Proline®
 Costar®
 Eppendorf®
 Finnpipette®
 Jencons Sealpette®
 Labpette™
 Nichiryo
 Oxford-Benchmate®
 Rainin EDP2™
 Socorex
 Titertek® Digital

Gel Loading Tip

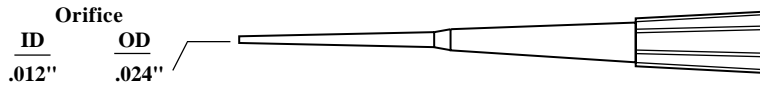

Product No.	Color	Package Type	Qty/ Unit	Qty/ Case	Price/ Unit
010	Natural	Bagged	1,000	10,000	
010-R204	Natural	204 Tip Rack	1,020	5,100	
010-R204S	Natural	204 Tip Rack - S	1,020	5,100	
010-S	Natural	Single Wrap - S	500	5,000*	
H-010-96R	Natural	H 96 Tip Rack	960	4,800	
H-010-96RS	Natural	H 96 Tip Rack-S	960	4,800	

Volume: 250-2500µl

For use with but not limited to:

Rainin EDP2™
 Rainin EDP-Plus™

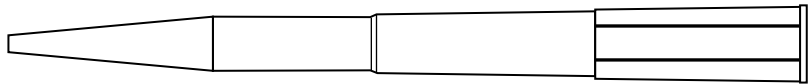

Product No.	Color	Package Type	Qty/ Unit	Qty/ Case	Price/ Unit
085	Natural	Bagged	500	5,000	
085-R100	Natural	100 Tip Rack	800	4,000	
085-R100S	Natural	100 Tip Rack - S	800	4,000	
085-S	Natural	Single Wrap - S	250	1,250*	

Volume: 500-2500µl

For use with but not limited to:

Eppendorf®
 Socorex

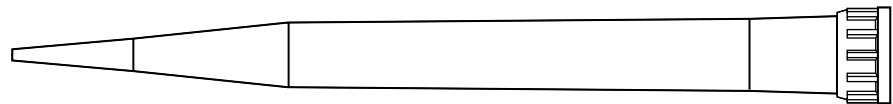

Product No.	Color	Package Type	Qty/ Unit	Qty/ Case	Price/ Unit
089	Natural	Bagged	500	2,500	
089-S	Natural	Single Wrap - S	250	1,250*	

Macro Tip

Volume: 1000-5000µl

For use with but not limited to:

MLA®
 Oxford-Benchmate®
 Pipetman®
 Rainin EDP2™
 Socorex

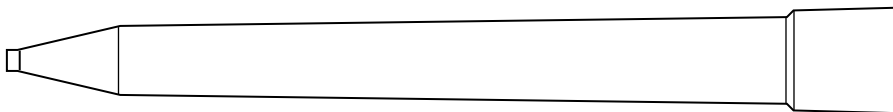

Product No.	Color	Package Type	Qty/ Unit	Qty/ Case	Price/ Unit
090	Natural	Bagged	250	2,500	
090-S	Natural	Single Wrap - S	250	1,250*	

Standard & Gel Loading

Macro Tip

Volume: 1000-5000µl

For use with but not limited to:

Finnpipette®
SMI

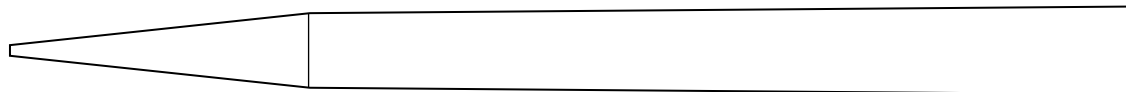

Product No.	Color	Package Type	Qty/ Unit	Qty/ Case	Price/ Unit
095	Natural	Bagged	250	2,500	
095-S	Natural	Single Wrap - S	250	1,250*	

Volume: 5000µl

For use with but not limited to:

Biohit Proline®
Eppendorf® Research
Jencons Sealpette®
Labpette™

Standard & Extra Long

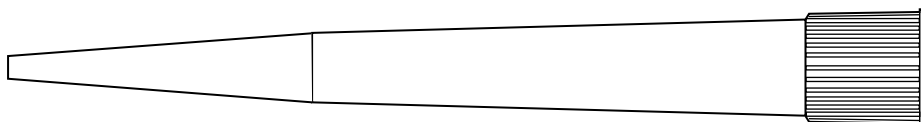

Product No.	Color	Package Type	Qty/ Unit	Qty/ Case	Price/ Unit
096	Natural	Bagged	250	2,500	
096-NXL	Natural	Bagged	250	2,500	

Volume: 1-10ml

For use with but not limited to:

Pipetman®

10ml Tip with graduations at 1.0ml intervals

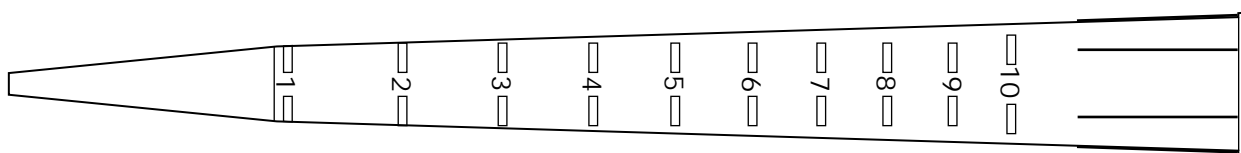

Product No.	Color	Package Type	Qty/ Unit	Qty/ Case	Price/ Unit
097	Natural	Bagged	200	2,000	

Volume: 100-1000µl

For use with but not limited to:

Biopet
Clay Adams® Selectapette®

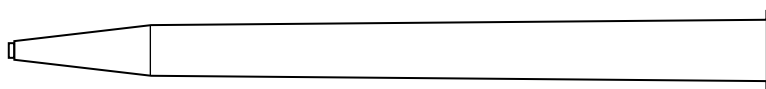

Product No.	Color	Package Type	Qty/ Unit	Qty/ Case	Price/ Unit
100	Natural	Bagged	500	5,000	
100-R	Natural	Spec. 250 Tip Rack	250	5,000	

Pipet Tips

1

Standard & Gel Loading

Volume: 0.1-10µl

For use with but not limited to:

Eppendorf® Reference and Research

Biohit Proline® (0.2 - 10µl)

Jencons Sealpette®

Labpette™

Nichiryo

Oxford-Benchmate®

Pipetman®

Ultra Micro "Nano Tip"

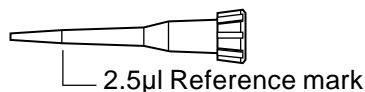

Product No.	Color	Package Type	Qty/ Unit	Qty/ Case	Price/ Unit
101	Natural	Bagged	1,000	10,000	
101-96R	Natural	96 Tip Rack	960	4,800	
101-96RS	Natural	96 Tip Rack - S	960	4,800	

Volume: 0.1-10µl

For use with but not limited to:

Pipetman®

Biohit Proline® (0.2 - 10µl)

Eppendorf® Reference and Research

Jencons Sealpette®

Labpette™

Nichiryo

Oxford-Benchmate®

Rainin

Socorex

Ultra Micro Tip

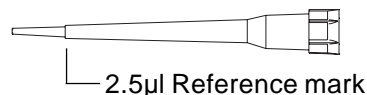

Product No.	Color	Package Type	Qty/ Unit	Qty/ Case	Price/ Unit
102	Natural	Bagged	1,000	10,000	
H-102-96R	Natural	H 96 Tip Rack	960	4,800	
H-102-96RS	Natural	H 96 Tip Rack - S	960	4,800	

Volume: 0.1-10µl

For use with but not limited to:

Pipetman®

Biohit Proline® (0.2 - 10µl)

Eppendorf® Reference and Research

Jencons Sealpette®

Labpette™

Nichiryo

Oxford-Benchmate®

Ultra Micro Gel Loading Tip



Product No.	Color	Package Type	Qty/ Unit	Qty/ Case	Price/ Unit
103	Natural	Bagged	1,000	10,000	
103-R204	Natural	204 Tip Rack	1,020	5,100	
103-R204S	Natural	204 Tip Rack- S	1,020	5,100	

Volume: 0.1-10µl

For use with but not limited to:

Pipetman®

Biohit Proline® (0.2 - 10µl)

Eppendorf® Reference and Research

Jencons Sealpette®

Labpette™, 8 & 12 Channel

Nichiryo

Oxford-Benchmate®

Rainin EDP2™

Ultra Micro Tip

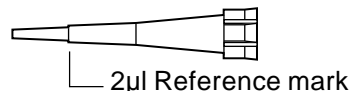

Product No.	Color	Package Type	Qty/ Unit	Qty/ Case	Price/ Unit
104	Natural	Bagged	1,000	10,000	
104-96R	Natural	96 Tip Rack	960	4,800	
104-96RS	Natural	96 Tip Rack - S	960	4,800	
H-104-96R	Natural	H 96 Tip Rack	960	4,800	
H-104-96RS	Natural	H 96 Tip Rack-S	960	4,800	
HRI-104	Natural	Insert-Mini H 96 Tip Rack	480	4,800	

8

w - with
w/o - without

H - Hinged
S - Sterile

* - may be purchased by the unit

Standard & Gel Loading

Volume: 5-200 μ l

For use with but not limited to:



Titertek®

Costar®

Finnpipette®

Nichiryo

MLA®

Oxford-Benchmate®

Pipetman®

Product No.	Color	Package Type	Qty/ Unit	Qty/ Case	Price/ Unit
105	Natural	Bagged	1,000	10,000	
105-96R	Natural	96 Tip Rack	960	4,800	
105-96RS	Natural	96 Tip Rack - S	960	4,800	
105-R480	Natural	Q-Stack ⁵	960	4,800	
105-R480S	Natural	Q-Stack ⁵ - S	480	4,800	

Volume: 5-300 μ l

For use with but not limited to:

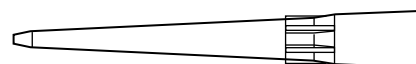

Titertek®

Costar®

Finnpipette®

Nichiryo

Oxford-Benchmate®

Sara-Pette®

Product No.	Color	Package Type	Qty/ Unit	Qty/ Case	Price/ Unit
106	Natural	Bagged	1,000	10,000	
106-96R	Natural	96 Tip Rack	960	4,800	
106-96RS	Natural	96 Tip Rack - S	960	4,800	

Volume: 1-300 μ l

For use with but not limited to:

Graduations at 10, 50, 100 & 200 μ l



Titertek®

Biohit Proline®

Costar®

Finnpipette®

Jencons Sealpette®

Labpette™, 8 & 12 Channel

Nichiryo

Oxford-Benchmate®

Pipetman® (P-200)

Product No.	Color	Package Type	Qty/ Unit	Qty/ Case	Price/ Unit
108-G	Natural	Bagged	1,000	10,000	
108-96RG	Natural	96 Tip Rack	960	4,800	
108-96RGS	Natural	96 Tip Rack - S	960	4,800	

Volume: 5-300 μ l

For use with but not limited to:

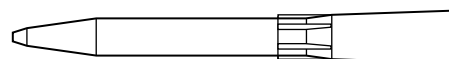

Titertek®

Biohit Proline®

Finnpipette®

Jencons Sealpette®

Nichiryo

Oxford-Benchmate®

Pipetman®

Sara-Pette®

Socorex

Product No.	Color	Package Type	Qty/ Unit	Qty/ Case	Price/ Unit
109	Natural	Bagged	1,000	10,000	
109-96R	Natural	96 Tip Rack	960	4,800	
109-96RS	Natural	96 Tip Rack - S	960	4,800	

Pipet Tips

1

Standard & Gel Loading

Standard Yellow Tip (Natural also available)

Volume: 1-200µl

For use with but not limited to:

Pipetman®

Costar® Onepette, 8 & 12 Pette®
Eppendorf®
Finnpipette®
Labpette™, 8 & 12 Channel
Nichiryo
Oxford-Benchmate®
Rainin EDP2™
Socorex
Titertek® Digital
Volac



Product No.	Yellow	Natural	Package Type	Qty/ Unit	Qty/ Case	Price/ Unit
110		110-N	Bagged	1,000	10,000	
110-R		110-RN	Stack Rack - 200	1,000	10,000	
110-R200		110-R200N	200 Tip Rack	1,000	10,000	
110-R200S		110-R200NS	200 Tip Rack - S	1,000	10,000	
110-96R		110-96RN	96 Tip Rack	960	4,800	
110-96RS		110-96RNS	96 Tip Rack - S	960	4,800	
110-S		110-NS	Single Wrap - S	500	5,000*	
110-R480		110-N-R480	Q-Stack ⁵	960	4,800	
110-R480S		110-N-R480S	Q-Stack ⁵ - S	480	4,800	
H-110-96R		H-110-96RN	H 96 Tip Rack	960	4,800	
H-110-96RS		H-110-96RNS	H 96 Tip Rack - S	960	4,800	
HRI-110		HRI-110-N	Insert for H 96 Tip Rack	480	4,800	

Volume: 1-200µl

For use with but not limited to:

Pipetman®

Costar® Onepette, 8 & 12 Pette®
Eppendorf®
Finnpipette®
Labpette™, 8 & 12 Channel
Nichiryo
Oxford-Benchmate®
Rainin EDP2™
Socorex
Titertek® Digital
Volac

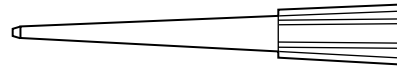

Beveled Orifice Tip (See #113-G for Graduated Version)

Product No.	Yellow	Natural	Package Type	Qty/ Unit	Qty/ Case	Price/ Unit
110-B		110-BN	Bagged	1,000	10,000	
110-RB		110-RBN	Stack Rack - 200	1,000	10,000	
110-R200B		110-R200BN	200 Tip Rack	1,000	10,000	
110-R200BS		110-R200BNS	200 Tip Rack - S	1,000	10,000	
110-96RB		110-96RBN	96 Tip Rack	960	4,800	
110-96RBS		110-96RBNS	96 Tip Rack - S	960	4,800	
110-BS		110-BNS	Single Wrap - S	500	5,000*	
110-B-R480		110-BN-R480	Q-Stack ⁵	960	4,800	
110-B-R480S		110-BN-R480S	Q-Stack ⁵ - S	480	4,800	
H-110-96RB		H-110-96RBN	H 96 Tip Rack	960	4,800	
H-110-96RBS		H-110-96RBNS	H 96 Tip Rack - S	960	4,800	
HRI-110-B		HRI-110-BN	Insert for H 96 Tip Rack	480	4,800	

Volume: 1-250µl

For use with but not limited to:

Pipetman®

Costar® Onepette, 8 & 12 Pette®
Eppendorf®
Finnpipette®
Labpette™, 8 & 12 Channel
Nichiryo
Oxford-Benchmate®
Rainin EDP2™
Socorex
Titertek® Digital
Volac

Thin Wall Orifice Tip

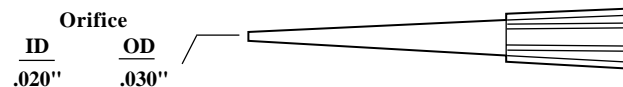

Product No.	Color	Package Type	Qty/ Unit	Qty/ Case	Price/ Unit
TW110-N	Natural	Bagged	1,000	10,000	
TW110-96RN	Natural	96 Tip Rack	960	4,800	
TW110-96RNS	Natural	96 Tip Rack - S	960	4,800	
H-TW110-96RN	Natural	H 96 Tip Rack	960	4,800	
H-TW110-96RNS	Natural	H 96 Tip Rack - S	960	4,800	
HRI-TW110-N	Natural	Insert for H 96 Tip Rack	480	4,800	

10

w - with
w/o - without

H - Hinged
S - Sterile

* - may be purchased by the unit

Standard & Gel Loading

Extra Long Tip to ensure maximum sampling

Volume: 1-200µl

For use with but not limited to:

Pipetman®

Costar® Onepette

Eppendorf®

Finnpipette®

Labpette™

Nichiryo

Oxford-Benchmate®

Rainin EDP2™

Volac

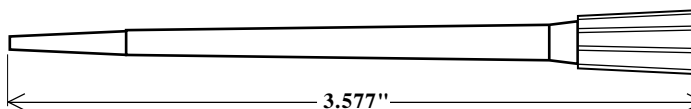

Product No.	Color	Package Type	Qty/ Unit	Qty/ Case	Price/ Unit
110-NXL	Natural	Bagged	1,000	5,000	
110-NXL-R204	Natural	204 Tip Rack	1,632	4,896	
110-NXL-R204S	Natural	204 Tip Rack - S	1,632	4,896	
110-NXL-S	Natural	Single Wrap - S	250	2,500*	

Standard Blue Tip (Natural also available) (See #112-G for Graduated Version)

Volume: 101-1000µl

For use with but not limited to:

Pipetman®

Costar®

Eppendorf®

Finnpipette®

Nichiryo

Oxford-Benchmate®

Rainin EDP2™

SMI Airpette®

Socorex

Titertek®

Volac

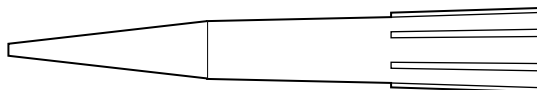

Product No.		Package Type	Qty/ Unit	Qty/ Case	Price/ Unit
<i>Blue</i>	<i>Natural</i>				
111	111-N	Bagged	1,000	10,000	
111-R	111-RN	Stack Rack - 100	1,000	5,000	
111-R100	111-R100N	100 Tip Rack	1,000	5,000	
111-R100S	111-R100NS	100 Tip Rack - S	1,000	5,000	
111-S	111-NS	Single Wrap - S	500	5,000*	
H-111-R100	H-111-R100N	H 100 Tip Rack	1,000	5,000	
H-111-R100S	H-111-R100NS	H 100 Tip Rack - S	1,000	5,000	

Extra Long Tip to ensure maximum sampling

Volume: 101-1000µl

For use with but not limited to:

Pipetman®

Costar®

Eppendorf®

Finnpipette®

Nichiryo

Oxford-Benchmate®

Rainin EDP2™

SMI Airpette®

Socorex

Titertek®

Volac

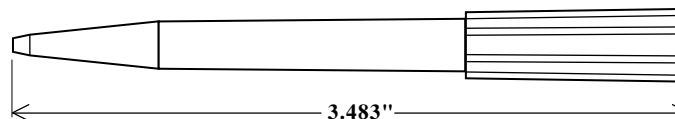

Product No.		Package Type	Qty/ Unit	Qty/ Case	Price/ Unit
<i>Blue</i>	<i>Natural</i>				
111-XL	111-NXL	Bagged	1,000	10,000	
111-XL-R	111-NXL-R	Stack Rack - 100	1,000	5,000	
111-XL-R100	111-NXL-R100	100 Tip Rack	1,000	5,000	
111-XL-R100S	111-NXL-R100S	100 Tip Rack - S	1,000	5,000	
111-XLS	111-NXLS	Single Wrap - S	500	5,000*	

Standard & Gel Loading

Graduations at 250, 500 & 1,000µl

Volume: 101-1000µl

For use with but not limited to:

Pipetman®
 Costar®
 Eppendorf®
 Finnpiquette®
 Nichiryo
 Oxford-Benchmate®
 Rainin EDP2™
 SMI Airpette®
 Socorex
 Titertek®
 Volac

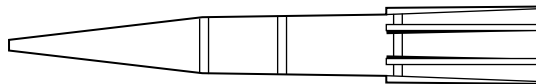

Product No.		Package Type	Qty/ Unit	Qty/ Case	Price/ Unit
<i>Blue</i>	<i>Natural</i>				
112-G	112-GN	Bagged	1,000	10,000	
112-RG	112-RGN	Stack Rack - 100	1,000	5,000	
112-R100G	112-R100GN	100 Tip Rack	1,000	5,000	
112-R100GS	112-R100GNS	100 Tip Rack - S	1,000	5,000	
112-GS	112-GNS	Single Wrap - S	500	5,000*	

Beveled Orifice Tip with graduations at 10, 50 & 100µl

Volume: 1-200µl

For use with but not limited to:

Pipetman®
 Costar® Onepette, 8 & 12 Pette®
 Eppendorf®
 Finnpiquette®
 Labpette™, 8 & 12 Channel
 MLA®
 Nichiryo
 Oxford-Benchmate®
 Rainin EDP2™
 Socorex
 Titertek® Digital
 Volac

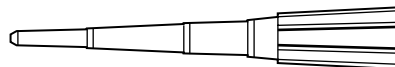

Product No.		Package Type	Qty/ Unit	Qty/ Case	Price/ Unit
<i>Yellow</i>	<i>Natural</i>				
113-G	113-GN	Bagged	1,000	10,000	
113-RG	113-RGN	Stack Rack - 200	1,000	10,000	
113-R200G	113-R200GN	200 Tip Rack	1,000	10,000	
113-R200GS	113-R200GNS	200 Tip Rack - S	1,000	10,000	
113-96RG	113-96RGN	96 Tip Rack	960	4,800	
113-96RGS	113-96RGNS	96 Tip Rack - S	960	4,800	
113-GS	113-GNS	Single Wrap - S	500	5,000*	
113-G-R480	113-GN-R480	Q-Stack ⁵	960	4,800	
113-G-R480S	113-GN-R480S	Q-Stack ⁵ - S	480	4,800	
H-113-96RG	H-113-96RGN	H 96 Tip Rack	960	4,800	
H-113-96RGS	H-113-96RGNS	H 96 Tip Rack - S	960	4,800	
HRI-113-G	HRI-113-GN	Insert for H 96 Tip Rack	480	4,800	

Standard & Gel Loading

Ultra Micro Tip

Volume: 0.5-10µl

For use with but not limited to:

Eppendorf®

Labpette™

Nichiryo

Oxford-Benchmate®

Socorex

Titertek® Plus

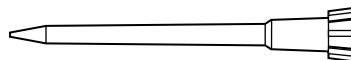

Product No.	Color	Package Type	Qty/ Unit	Qty/ Case	Price/ Unit
114	Natural	Bagged	1,000	10,000	
114-R100	Natural	100 Tip Rack	1,000	5,000	
114-R100S	Natural	100 Tip Rack - S	1,000	5,000	
114-S	Natural	Single Wrap - S	500	5,000*	
H-114-96R	Natural	H 96 Tip Rack	960	4,800	
H-114-96RS	Natural	H 96 Tip Rack - S	960	4,800	

Volume: 1-200µl

For use with but not limited to:

Eppendorf®

Brinkman -Transferpette®

Costar®

Finnpipette®

Labpette™, 8 & 12 Channel

Nichiryo

Oxford-Benchmate®

Socorex



Product No.	Color	Package Type	Qty/ Unit	Qty/ Case	Price/ Unit
115	115-N	Bagged	1,000	10,000	
115-R	115-RN	Stack Rack - 200	1,000	10,000	
115-R200	115-R200N	200 Tip Rack	1,000	10,000	
115-R200S	115-R200NS	200 Tip Rack - S	1,000	10,000	
115-96R	115-96RN	96 Tip Rack	960	4,800	
115-96RS	115-96RNS	96 Tip Rack - S	960	4,800	
115-S	115-NS	Single Wrap - S	500	5,000*	

Volume: 1-200µl

For use with but not limited to:

Eppendorf®

Finnpipette®

Extra Long Tip *to ensure maximum sampling*

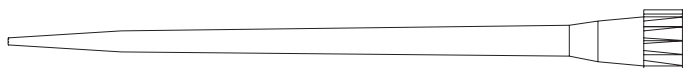

Product No.	Color	Package Type	Qty/ Unit	Qty/ Case	Price/ Unit
115-NXL	Natural	Bagged	1,000	5,000	
115-NXL-R100	Natural	100 Tip Rack	800	4,000	
115-NXL-R100S	Natural	100 Tip Rack - S	800	4,000	
115-NXLS	Natural	Single Wrap - S	250	2,500*	

Pipet Tips

1

Standard & Gel Loading

Volume: 101-1000µl

For use with but not limited to:

Eppendorf®
 Biohit Proline®
 Finnpipette®
 Jencons Sealpette®
 Labpette™
 Nichiryo
 Oxford-Benchmate®
 SMI
 Socorex
 Titertek®

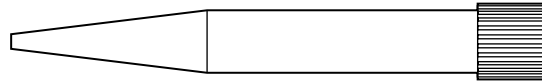

Product No.		Package Type	Qty/ Unit	Qty/ Case	Price/ Unit
<i>Blue</i>	<i>Natural</i>				
116	116-N	Bagged	1,000	10,000	
116-R	116-RN	Stack Rack - 100	1,000	5,000	
116-R100	116-R100N	100 Tip Rack	1,000	5,000	
116-R100S	116-R100NS	100 Tip Rack - S	1,000	5,000	
116-S	116-NS	Single Wrap - S	500	5,000*	

Volume: 5-250µl

For use with but not limited to:

Biohit Proline®
 Costar® Onepette, 8 & 12 Pette®
 Finnpipette®
 Eppendorf®
 Jencons Sealpette®
 Nichiryo
 Oxford-Benchmate®

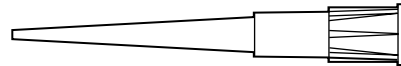

Product No.		Package Type	Qty/ Unit	Qty/ Case	Price/ Unit
<i>Yellow</i>	<i>Natural</i>				
117	117-N	Bagged	1,000	10,000	
117-96R	117-96RN	96 Tip Rack	960	4,800	
117-96RS	117-96RNS	96 Tip Rack - S	960	4,800	

Volume: 1-200µl

For use with but not limited to:

Pipetman®
 Biohit Proline®
 Costar® Onepette, 8 & 12 Pette®
 Eppendorf®
 Finnpipette®
 Jencons Sealpette®
 Labpette™, 8 & 12 Channel
 Nichiryo
 Oxford-Benchmate®
 Rainin EDP2™
 Socorex
 Titertek®
 Volac

Large Orifice Tip



Product No.		Package Type	Qty/ Unit	Qty/ Case	Price/ Unit
<i>Yellow</i>	<i>Natural</i>				
118	118-N	Bagged	1,000	10,000	
118-R	118-RN	Stack Rack - 200	1,000	10,000	
118-96R	118-96RN	96 Tip Rack	960	4,800	
118-96RS	118-96RNS	96 Tip Rack - S	960	4,800	
118-S	118-NS	Single Wrap - S	500	5,000*	
H-118-96R	H-118-96RN	H 96 Tip Rack	960	4,800	

Standard & Gel Loading

Volume: 101-1000µl

For use with but not limited to:

Pipetman®

Costar®

Eppendorf®

Excalibur

Finnpipette®

Nichiryo

Oxford-Benchmate®

SMI

Socorex

Rainin EDP2™

Titertek®

Volac

Large Orifice Tip

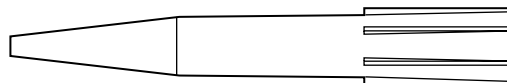

Product No.	Color	Package Type	Qty/ Unit	Qty/ Case	Price/ Unit
119	Natural	Bagged	1,000	10,000	
119-R	Natural	Stack Rack - 100	1,000	5,000	
119-R100	Natural	100 Tip Rack	1,000	5,000	
119-R100S	Natural	100 Tip Rack - S	1,000	5,000	
119-S	Natural	Single Wrap - S	500	5,000*	

Large Orifice Extra Long Tip *to ensure maximum sampling*

Volume: 101-1000µl

For use with but not limited to:

Pipetman®

Costar®

Eppendorf®

Finnpipette®

Nichiryo

Oxford-Benchmate®

SMI Airpettor

Socorex

Titertek®

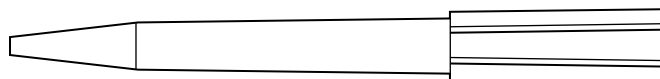

Product No.	Color	Package Type	Qty/ Unit	Qty/ Case	Price/ Unit
119-NXL	Natural	Bagged	1,000	10,000	
119-NXL-R100	Natural	100 Tip Rack	1,000	5,000	
119-NXL-R100S	Natural	100 Tip Rack - S	1,000	5,000	

Small MLA Tip

Volume: 5-200µl

For use with but not limited to:

MLA™

Ames

Costar® Onepette

Nichiryo

Oxford-Benchmate®

Pipetman®

SMI Airpettor



	Color	Package Type	Qty/ Unit	Qty/ Case	Price/ Unit
120	Natural	Bagged	1,000	10,000	
120-R	Natural	Stack Rack - 200	1,000	10,000	
120-R200	Natural	200 Tip Rack	1,000	10,000	
120-R200S	Natural	200 Tip Rack - S	1,000	10,000	
120-S	Natural	Single Wrap - S	500	5,000*	

Pipet Tips

1

Standard & Gel Loading

Volume: 250-1000µl

For use with but not limited to:

MLA®

Large MLA® Tip



Product No.	Color	Package Type	Qty/ Unit	Qty/ Case	Price/ Unit
121	Natural	Bagged	1,000	10,000	
121-R	Natural	Stack Rack - 100	1,000	5,000	
121-R100	Natural	100 Tip Rack	1,000	5,000	
121-R100S	Natural	100 Tip Rack - S	1,000	5,000	
121-S	Natural	Single Wrap - S	500	5,000*	

Volume: 100-1300µl

For use with but not limited to:

Matrix

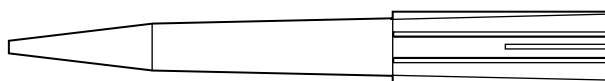

Product No.	Color	Package Type	Qty/ Unit	Qty/ Case	Price/ Unit
122	Natural	Bagged	1,000	10,000	
122-96R	Natural	96 Tip Rack	960	4,800	
122-96RS	Natural	96 Tip Rack - S	960	4,800	
122-S	Natural	Single Wrap - S	250	2,500*	

Volume: 0.5-10µl

For use with but not limited to:

Eppendorf®

Nichiryo

Oxford-Benchmate®

Socorex

Ultra Micro Gel Loading Tip

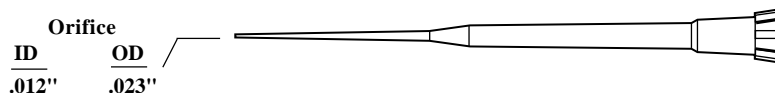

Product No.	Color	Package Type	Qty/ Unit	Qty/ Case	Price/ Unit
123	Natural	Bagged	1,000	10,000	
123-R204	Natural	204 Tip Rack	1,632	4,896	
123-R204S	Natural	204 Tip Rack - S	1,632	4,896	
123-S	Natural	Single Wrap - S	500	5,000*	

Volume: 0.5-10µl

For use with but not limited to:

Eppendorf®

Nichiryo

Oxford-Benchmate®

Socorex

Ultra Micro Gel Loading Tip

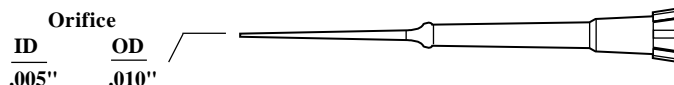

Product No.	Color	Package Type	Qty/ Unit	Qty/ Case	Price/ Unit
124-R204	Natural	204 Tip Rack	1,020	10,200*	
124-R204S	Natural	204 Tip Rack - S	1,020	10,200*	

Standard & Gel Loading

Volume: 25-200µl

For use with but not limited to:

Costar®

Finnpipette®

MLA®

Nichiryo

Oxford-Benchmate®

Pipetman®

Titertek® Digital

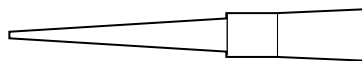

Product No.	Color	Package Type	Qty/ Unit	Qty/ Case	Price/ Unit
125	Natural	Bagged	1,000	10,000	
125-96R	Natural	96 Tip Rack	960	4,800	
125-96RS	Natural	96 Tip Rack - S	960	4,800	

Volume: 50-1200µl

For use with but not limited to:

Biohit Proline®

Jencons Sealpette®

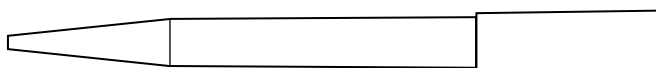

Product No.	Color	Package Type	Qty/ Unit	Qty/ Case	Price/ Unit
126	Natural	Bagged	1,000	10,000	
126-96R	Natural	96 Tip Rack	960	4,800	
126-96RS	Natural	96 Tip Rack - S	960	4,800	
126-S	Natural	Single Wrap - S	250	2,500*	

Volume: 50-1500µl

For use with but not limited to:

Titertek® Multi-Stepper

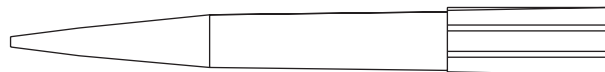

Product No.	Color	Package Type	Qty/ Unit	Qty/ Case	Price/ Unit
127	Natural	Bagged	1,000	10,000	
127-96R	Natural	96 Tip Rack	960	4,800	
127-96RS	Natural	96 Tip Rack - S	960	4,800	
127-S	Natural	Single Wrap - S	250	2,500*	

Volume: 1250µl

For use with but not limited to:

Eppendorf®

Repeater™ Plus/8™ (1.25ml)
with Cartridge-B

Reference & Research

100-1000ul

Model 4850 Electronic

500-1000ul

Biohit Proline® 50-1000ul

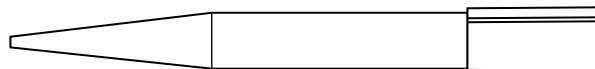

Product No.	Color	Package Type	Qty/ Unit	Qty/ Case	Price/ Unit
128	Natural	Bagged	1,000	10,000	
128-96R	Natural	96 Tip Rack	960	4,800	
128-96RS	Natural	96 Tip Rack - S	960	4,800	

Pipet Tips

1

Standard & Gel Loading

Volume: 5-200µl

For use with but not limited to:

Oxford® Sampler 8000
Abbott
Helena®
Pfizer

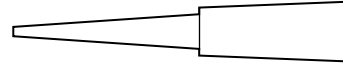

Product No.	Color	Package Type	Qty/ Unit	Qty/ Case	Price/ Unit
130	Natural	Bagged	1,000	10,000	
130-R	Natural	Stack Rack - 200	1,000	10,000	
130-R200	Natural	200 Tip Rack	1,000	10,000	
130-R200S	Natural	200 Tip Rack - S	1,000	10,000	

Volume: 250-500µl

For use with but not limited to:

Oxford® Sampler 8000
Abbott
Centrifichem® Analyzer
Helena®
Pfizer



Product No.	Color	Package Type	Qty/ Unit	Qty/ Case	Price/ Unit
131	Yellow	Bagged	1,000	10,000	

Volume: 600-1000µl

For use with but not limited to:

Oxford® Sampler 8000
Abbott
Finnpipette®
Helena®
Nichiryo
Oxford-Benchmate®
Pfizer

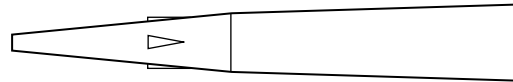

Product No.	Color	Package Type	Qty/ Unit	Qty/ Case	Price/ Unit
132	Green	Bagged	1,000	10,000	

Small Slimline Tip

Volume: 1-200µl

For use with but not limited to:

Oxford® Sampler P-3000 & P-7000
Helena®

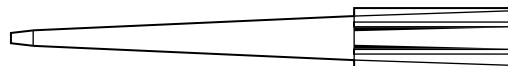

Product No.	Color	Package Type	Qty/ Unit	Qty/ Case	Price/ Unit
135	Natural	Bagged	1,000	10,000	
135-R	Natural	Stack Rack - 100	1,000	5,000	
135-S	Natural	Single Wrap - S	500	5,000*	

Standard & Gel Loading

For Automated Liquid Handling refer to page 41

Volume: 5-1000µl

For use with but not limited to:

Finnpipette®

Labpette™

Nichiryo

Oxford-Benchmate®

Oxford® Sampler P-3000 & P-7000

SMI Airpettor

Zymark®

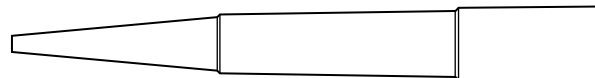

	Product No.	Color	Package Type	Qty/ Unit	Qty/ Case	Price/ Unit
	137	Blue	Bagged	500	5,000	
	137-R	Blue	Stack Rack - 100	1,000	5,000	
	137-R100	Blue	100 Tip Rack	1,000	5,000	
	137-R100S	Blue	100 Tip Rack - S	1,000	5,000	

Volume: 10-500µl

For use with but not limited to:

Centaur

Sherwood-Lancer®

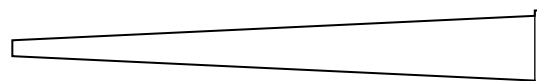

	Product No.	Color	Package Type	Qty/ Unit	Qty/ Case	Price/ Unit
	140	Natural	Bagged	1,000	10,000	

Volume: 10-500µl

For use with but not limited to:

Beckman®-Bun,

Glucose Analyzer

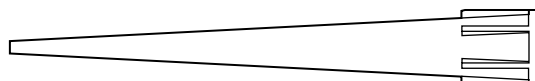

	Product No.	Color	Package Type	Qty/ Unit	Qty/ Case	Price/ Unit
	145	Natural	Bagged	1,000	10,000	
	145-R100	Natural	100 Tip Rack	1,000	5,000	

Pipet Tips

1

Standard & Gel Loading

Volume: 300µl

For use with but not limited to:

Biohit Proline®
 Costar® Onepette, 8 & 12 Pette®
 Eppendorf® Ref. 50-200µl
 Eppendorf® Res. 10-200µl
 Finnpiptette® 40-200µl, 50-300µl
 Jencons Sealpette®
 Labpette™
 Pipetman® P-200 50-200µl
 Rainin R-200 50-200µl
 Titertek® 40-200µl, 50-300µl

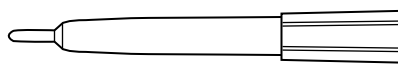

Product No.	Color	Package Type	Qty/ Unit	Qty/ Case	Price/ Unit
169	Natural	Bagged	1,000	10,000	
169-96R	Natural	96 Tip Rack	960	4,800	
169-96RS	Natural	96 Tip Rack - S	960	4,800	

Volume: 5-250µl

For use with but not limited to:

Socorex
 Biohit Proline®
 Eppendorf® Reference and
 Research
 Finnpiptette® Digital
 Labpette™
 Nichiryo
 Oxford-Benchmate®
 Rainin EDP2™
 Volac

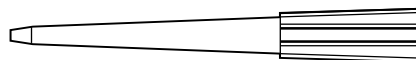

Product No.	Color	Package Type	Qty/ Unit	Qty/ Case	Price/ Unit
177	Natural	Bagged	1,000	10,000	
177-R	Natural	Stack Rack - 200	1,000	10,000	
177-96R	Natural	96 Tip Rack	960	4,800	
177-96RS	Natural	96 Tip Rack - S	960	4,800	

For use with but not limited to:

QSP BBL cup (page 91)

Tip for BBL® Fibrometer® Low Density Polyethylene

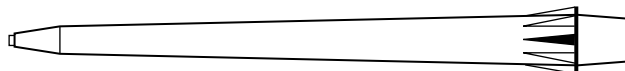

Product No.	Color	Package Type	Qty/ Unit	Qty/ Case	Price/ Unit
210	Natural	Bagged	1,000	10,000	

Certified RNase, DNase & Pyrogen Free



Tested by an independent laboratory, these pre-sterilized pipet tips are certified to be RNase, DNase and Pyrogen Free within detectable limits.

- Certificate(s) of analysis available upon request.
- Pre-sterilized by Gamma-Cobalt 60 Irradiation.

Ultra Micro Tip

Volume: 0.1-10 μ l

For use with but not limited to:

Pipetman[®]

Biohit Proline[®]

Eppendorf[®] Reference and
Research

Jencons Sealpette[®]

Labpette[™]

Nichiryo

Oxford-Benchmate[®]

Rainin EDP2[™]

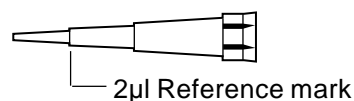

Product No.	Color	Package Type	Qty/ Unit	Qty/ Case	Price/ Unit
C104-96RS	Natural	96 Tip Rack - S	960	4,800	

Standard Tip

Volume: 1-200 μ l

For use with but not limited to:

Pipetman[®]

Costar[®] Onepette, 8 & 12 Pette[®]

Eppendorf[®]

Finnpipette[®]

Labpette[™]

Nichiryo

Oxford-Benchmate[®]

Rainin EDP2[™]

Socorex

Titertek[®] Digital

Volac



Product No.	Color	Package Type	Qty/ Unit	Qty/ Case	Price/ Unit
C110-96RNS	Natural	96 Tip Rack - S	960	4,800	

Pipet Tips

1

Certified RNase, DNase & Pyrogen Free

Standard Tip

Volume: 101-1000 μ l

For use with but not limited to:

Pipetman[®]

Costar[®]

Eppendorf[®]

Finnpipette[®]

Nichiryo

Oxford-Benchmate[®]

Rainin EDP2[™]

SMI Airpettor

Socorex

Titertek[®]

Volac

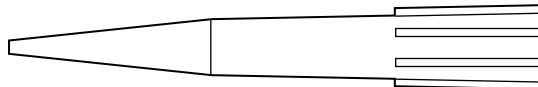

Product No.	Color	Package Type	Qty/ Unit	Qty/ Case	Price/ Unit
C111-R100NS	Natural	100 Tip Rack - S	1,000	5,000	

Beveled Orifice Tip *with graduations at 10, 50 & 100 μ l*

Volume: 1-200 μ l

For use with but not limited to:

Pipetman[®]

Costar[®] Onepette, 8 & 12 Pette[®]

Eppendorf[®]

Finnpipette[®]

Labpette[™]

Nichiryo

Oxford-Benchmate[®]

Rainin EDP2[™]

Socorex

Titertek[®] Digital

Volac

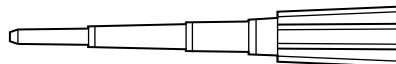

Product No.	Color	Package Type	Qty/ Unit	Qty/ Case	Price/ Unit
C113-96RGNS	Natural	96 Tip Rack - S	960	4,800	

Ultra Micro Tip

Volume: 0.5-10 μ l

For use with but not limited to:

Eppendorf[®]

Nichiryo

Oxford-Benchmate[®]

Socorex

Titertek[®] Plus

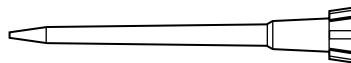

Product No.	Color	Package Type	Qty/ Unit	Qty/ Case	Price/ Unit
C114-R100S	Natural	100 Tip Rack - S	1,000	5,000	

Low Adhesion

For those applications where optimal yield and minimal sample loss are required.

Low Adhesion Pipet Tips are injection molded with scientifically blended resins to minimize liquid retention and ensure optimal sample yield. This advanced technique eliminates the use of lubricants that may be harmful to priceless samples. Tips are autoclavable using standard autoclaving guideline shown on page 98.

Our Superior Quality Low Adhesion Pipet Tips are ideal for DNA and PCR* applications as well as sensitive clinical assays, quantitative analysis, quality control or any other applications where optimal yield and minimal sample loss is required. Customers can select from six different pipet tips with volume ranges from 0.1µl to 1000µl.

*PCR process is covered by patents owned by Hoffman-LaRoche Inc.

Ultra Micro Tip

Volume: 0.1-10µl

For use with but not limited to:

Pipetman®

Biohit Proline®

Eppendorf® Reference and Research

Jencons Sealpette®

Labpette™

Nichiryo

Oxford-Benchmate®

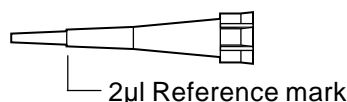

Product No.	Color	Package Type	Qty/ Unit	Qty/ Case	Price/ Unit
104-SC	Natural	Bagged	500	5,000	
104-96R-SC	Natural	96 Tip Rack	960	4,800	
104-96R-SC-S	Natural	96 Tip Rack - S	960	4,800	
H-104-96R-SC	Natural	H 96 Tip Rack	960	4,800	
H-104-96R-SC-S	Natural	H 96 Tip Rack - S	960	4,800	

Beveled Orifice Tip

Volume: 1-200µl

For use with but not limited to:

Pipetman®

Costar® Onepette, 8 & 12 Pette®

Eppendorf®

Finnpipette®

Labpette™

Nichiryo

Oxford-Benchmate®

Rainin EDP2™

Socorex

Titertek® Digital

Volac



Product No.	Color	Package Type	Qty/ Unit	Qty/ Case	Price/ Unit
110-BN-SC	Natural	Bagged	500	5,000	
H-110-96RBN-SC	Natural	H 96 Tip Rack	960	4,800	
H-110-96RBN-SC-S	Natural	H 96 Tip Rack - S	960	4,800	

Pipet Tips

1

Low Adhesion

For those applications where optimal yield and minimal sample loss are required.

Volume: 101-1000µl

For use with but not limited to:

Pipetman®
 Costar®
 Eppendorf®
 Finnpiquette®
 Nichiryo
 Oxford-Benchmate®
 Rainin EDP2™
 SMI Airpettor
 Socorex
 Titertek®
 Volac

Standard Tip

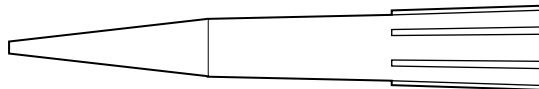

Product No.	Color	Package Type	Qty/ Unit	Qty/ Case	Price/ Unit
111-N-SC	Natural	Bagged	500	5,000	
H-111-R100N-SC	Natural	H 100 Tip Rack	1,000	5,000	
H-111-R100N-SC-S	Natural	H 100 Tip Rack - S	1,000	5,000	

Volume: 101-1000µl

For use with but not limited to:

Pipetman®
 Costar®
 Eppendorf®
 Finnpiquette®
 Nichiryo
 Oxford-Benchmate®
 Rainin EDP2™
 SMI Airpettor
 Socorex
 Titertek®
 Volac

Graduations at 250, 500, & 1000µl

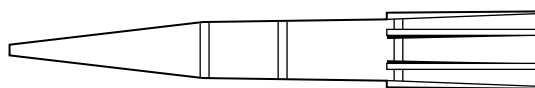

Product No.	Color	Package Type	Qty/ Unit	Qty/ Case	Price/ Unit
112-GN-SC	Natural	Bagged	500	5,000	
112-R100GN-SC	Natural	100 Tip Rack	1,000	5,000	
112-R100GN-SC-S	Natural	100 Tip Rack - S	1,000	5,000	

Volume: 1-200µl

For use with but not limited to:

Pipetman®
 Costar® Onepette, 8 & 12 Pette®
 Eppendorf®
 Finnpiquette®
 Labpette™
 Nichiryo
 Oxford-Benchmate®
 Rainin EDP2™
 Socorex
 Titertek® Digital
 Volac

Beveled Orifice Tip with graduations at 10, 50 & 100µl

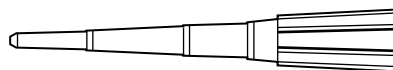

Product No.	Color	Package Type	Qty/ Unit	Qty/ Case	Price/ Unit
113-GN-SC	Natural	Bagged	500	5,000	
113-96RGN-SC	Natural	96 Tip Rack	960	4,800	
113-96RGN-SC-S	Natural	96 Tip Rack - S	960	4,800	
HRI-113-GN-SC	Natural	H 96 Tip Rack - Insert	480	4,800	
H-113-96RGN-SC	Natural	H 96 Tip Rack	960	4,800	
H-113-96RGN-SC-S	Natural	H 96 Tip Rack - S	960	4,800	

Volume: 0.5-10µl

For use with but not limited to:

Eppendorf®
 Nichiryo
 Oxford-Benchmate®
 Socorex
 Titertek® Plus

Ultra Micro Tip

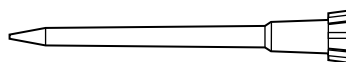

Product No.	Color	Package Type	Qty/ Unit	Qty/ Case	Price/ Unit
114-SC	Natural	Bagged	500	5,000	
114-R100-SC	Natural	100 Tip Rack	1,000	5,000	
114-R100-SC-S	Natural	100 Tip Rack - S	1,000	5,000	
H-114-96R-SC	Natural	H 96 Tip Rack	960	4,800	
H-114-96R-SC-S	Natural	H 96 Tip Rack - S	960	4,800	

QLS[®] Quality Loading System

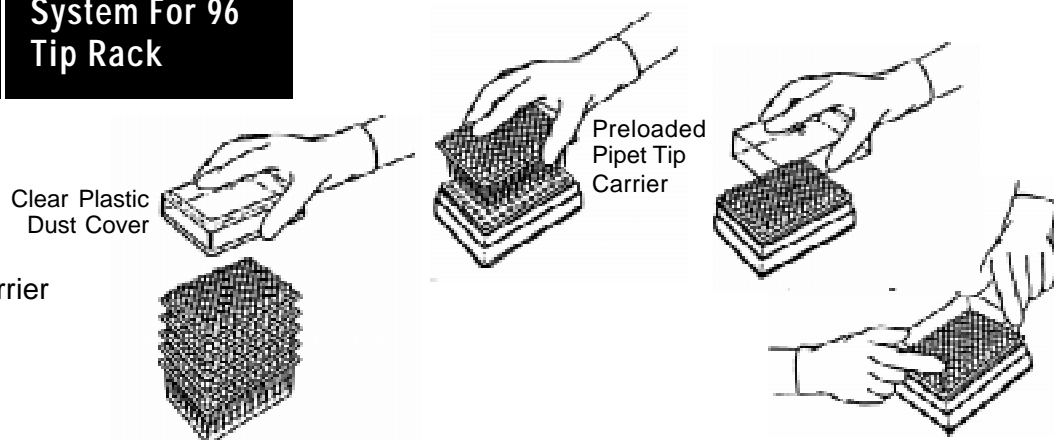

Note: Pipet Tip Carrier is autoclavable.
Do Not autoclave Blister Pack.

QLS[®] is our economical, easy to use, environmentally conscious solution to tip racking; the problems associated with empty racks and the amount of plastic labs are throwing away. The demand for this type of product is ever increasing, as more and more people become committed to the preservation of our environment.

Patented Design

Our patented tip carrier has 96 tips securely locked into place for easy alignment with the rack. Tips are easily released with pressure on the corners of the carrier using four fingers or a dust cover.

Easy to Use

Each unit of QLS[®] consists of five preloaded tip carriers, 96 tips each, nested in a blister pack. Easy to follow directions are pre-printed on each sleeve and the entire unit is shrink wrapped. With ease and speed, one to five racks are loaded at a time.

Economic

Priced lower than pre-racked tips, immediate savings are realized by reloading empty racks that have already been paid for. Additional savings are also gained through the reduction of valuable storage space.

Environmentally Conscious

QLS[®] eliminates 80% of plastic waste. In addition, all materials used in the manufacture of our loading system are recyclable. Both are significant steps toward the preservation of our environment.

Versatile

Although designed specifically for use with QSP[®] racks, our Quality Loading System is compatible with a number of other racks. Three styles of empty QSP[®] racks are available (see page 27) for those who need replacements. Our racks are designed to withstand numerous autoclave cycles.

QLS is a Registered Trademark of Quality Scientific Plastics
U.S. Patent 5,487,997

Pipet Tips

1

QLS® Quality Loading System

Volume: 1-200µl

For use with but not limited to:

Pipetman®

Costar® Onepette, 8 & 12 Pette®

Eppendorf®

Finnpipette®

Labpette™

Nichiryo

Oxford-Benchmate®

Rainin EDP2™

Socorex

Titertek® Digital

Volac

Standard Orifice Tip

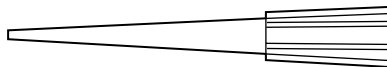

Product No.	Color	Package Type	Qty/ Unit	Qty/ Case	Price/ Unit
QLS-110	Yellow	QLS	480	4,800	
QLS-110-N	Natural	QLS	480	4,800	

Volume: 1-200µl

For use with but not limited to:

Pipetman®

Costar® Onepette, 8 & 12 Pette®

Eppendorf®

Finnpipette®

Labpette™

Nichiryo

Oxford-Benchmate®

Rainin EDP2™

Socorex

Titertek® Digital

Volac

Beveled Orifice Tip

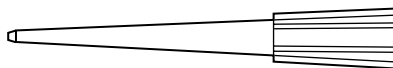

Product No.	Color	Package Type	Qty/ Unit	Qty/ Case	Price/ Unit
QLS-110-B	Yellow	QLS	480	4,800	
QLS-110-BN	Natural	QLS	480	4,800	

Volume: 1-250µl

For use with but not limited to:

Pipetman®

Costar® Onepette, 8 & 12 Pette®

Eppendorf®

Finnpipette®

Labpette™

Nichiryo

Oxford-Benchmate®

Rainin EDP2™

Socorex

Titertek® Digital

Volac

Thin Wall Orifice Tip



Product No.	Color	Package Type	Qty/ Unit	Qty/ Case	Price/ Unit
QLS-TW110-N	Natural	QLS	480	4,800	

Volume: 1-200µl

For use with but not limited to:

Pipetman®

Costar® Onepette, 8 & 12 Pette®

Eppendorf®

Finnpipette®

Labpette™

Nichiryo

Oxford-Benchmate®

Rainin EDP2™

Socorex

Titertek® Digital

Volac

Beveled Orifice Tip with graduations at 10, 50 & 100µl

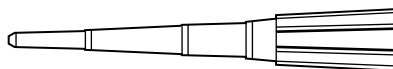

Product No.	Color	Package Type	Qty/ Unit	Qty/ Case	Price/ Unit
QLS-113-G	Yellow	QLS	480	4,800	
QLS-113-GN	Natural	QLS	480	4,800	

QLS[®] Quality Loading System

Racks without Pipet Tips

1

Hinged Rack

Superior construction provides maximum support to the insert for mounting tips on multichannel pipetters. Each insert will hold 96 tips in the 8 X 12 format. The unique closure is easy to open and close yet remains latched when necessary. QSP[®] hinged racks feature "stacking walls" on both the top and bottom of the rack to provide extra stability when stacking one on top of the other. The top can be left partially open for complete steam penetration when autoclaving.

Each rack insert has four small posts designed to fit into the four holes of the QLS[®] Tip carrier. Once snapped together, the tip carrier remains securely in place (no moving or lifting) during the pipetting process.

Product No.	Color	Package Type	Qty/ Unit	Qty/ Case	Price/ Unit
QLS-H-9062	Blue	Box	10	10	
QLS-H-9062-PB	Blue	Box	96	96	

Drawing not to size

Standard Rack with Lift-off Cover

QSP[®]'s versatile 96 tip rack, with its convenient 8 X 12 format, accommodates multi and single channel pipetters. Precise hole spacing offers perfect alignment with 96 well micro titer plates. This rack has the popular lift off cover and sonically welded base.

Product No.	Color	Package Type	Qty/ Unit	Qty/ Case	Price/ Unit
QLS-9062	Blue	Box	10	10	
QLS-9062-PB	Blue	Box	108	108	

Drawing not to size

Heavy Duty Compartment Rack with Lift-off Cover

The inner wall structure adds extra stability, making it ideal for use with robotic handling systems and multichannel pipetters. Our heavy duty rack features 96 individual inner compartments keeping tips separated from each other to eliminate the possibility of cross contamination. It is completed with our lift-off cover and sonically welded base.

Internal view of individual tip compartments

Product No.	Color	Package Type	Qty/ Unit	Qty/ Case	Price/ Unit
QLS-9102	Blue	Box	10	10	
QLS-9102-PB	Blue	Box	108	108	

Drawing not to size

First-Class Filter Tips



Pre-sterilized (Gamma Irradiation) Certified RNase, DNase and Pyrogen free; also metal free



Autoclavable Filter Tips (non-sterilized) Certified RNase and DNase free; also metal free.

QSP® First-Class Filter Tips are specifically designed to prevent airborne contaminants from coming in contact with the barrel of the pipetter. In addition, they prevent liquid bypass should accidental over-pipetting occur, yet allow for complete uncontaminated sample retrieval – a major concern for researchers who are working with small and precious amounts of sample.

Our First-Class Filter Tips utilize a small micron filter to prevent liquid bypass. We do not coat our filters with any sealing agents. Filters known as "self-sealing" are coated with a sealing agent to prevent liquid bypass. Consequently, the sealing agent also precludes sample recovery and can cause contamination.

Our pipet tips are manufactured of premium grade (metal free) polypropylene, are subjected to the most rigid quality control in the industry and meet or exceed O.E.M. specifications. Our First-Class (small micron) filter is manufactured of high density polyethylene. The insertion of a small micron filter into a pipet tip is a patented technology (U.S. Patent 5,364,595) requiring a license.

With over thirty different tips ranging in capacities from 5µl to 5000µl, QSP has the largest selection of filter tips on the market.

NOTE: Sterilized Filter Tips are not designed for autoclaving. The filter may become dislodged if autoclaved. We do offer autoclavable filter tips created with sophisticated molding techniques that eliminate the possibility of filters dislodging after autoclaving.

First-Class Filter Tips

Gel Loading Tip

Max. Capacity 20µl

For use with but not limited to:

Pipetman® P-20 2-20µl
 Costar® Onepette 1-20µl
 Eppendorf® Ref. & Res. 2-20µl
 Labpette™ 2-20µl
 MLA® 20µl
 Socorex 822 2-20µl

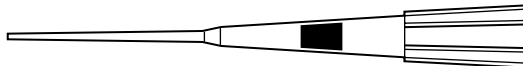

Product No.	Package Type	Qty/ Unit	Qty/ Case	Price/ Unit
F010-R204S-20	204 Tip Rack - S	1,020	5,100	
F010-S-20	Single Wrap - S	100	1,000	
FA010-R204-20	204 Tip Rack - Autoclavable	1,020	5,100	
FA010-20	Bagged - Autoclavable	1,000	5,000	

Max. Capacity 100µl

For use with but not limited to:

Pipetman®
 P-100 10-100µl
 P-200 50-200µl
 Biohit Proline®
 elec. sing. chan. 5-100µl
 man. sing. chan. 5-50µl
 man. sing. chan. 50-200µl
 Costar® Onepette 20-200µl
 Eppendorf® 10-100µl, 20-200µl
 Finnpipette® 5-40µl, 40-200µl
 Jencons Sealpette®
 elec. sing. chan. 5-100µl
 man. sing. chan. 5-50µl
 man. sing. chan. 50-200µl
 Labpette™ 20-200µl
 MLA® 20µl & 100µl
 Nichiryo 40-200µl
 Oxford-Benchmate® 40-200µl
 Socorex 20-200µl

Gel Loading Tip

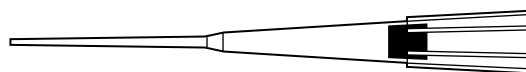

Product No.	Package Type	Qty/ Unit	Qty/ Case	Price/ Unit
F010-R204S-100	204 Tip Rack - S	1,020	5,100	
F010-S-100	Single Wrap - S	100	1,000	
FA010-R204-100	204 Tip Rack - Autoclavable	1,020	5,100	
FA010-100	Bagged - Autoclavable	1,000	5,000	

Macro Tip

Max. Capacity 5000µl

For use with but not limited to:

Pipetman® P-5000 0.5-5ml
 Oxford-Benchmate® 1-5ml
 Socorex 0.5-5ml

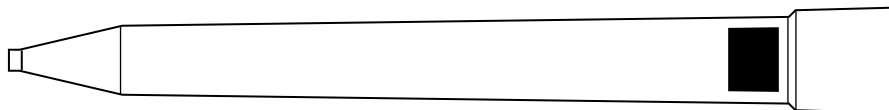

Product No.	Package Type	Qty/ Unit	Qty/ Case	Price/ Unit
F090-100S-5000	Bagged - S	100	1,000	
FA090-5000	Bagged - Autoclavable	100	1,000	

Pipet Tips

1

First-Class Filter Tips

Max. Capacity 5µl

For use with but not limited to:

Eppendorf® Ref. and Res.

0.1-2.5µl

0.5-10µl

Biohit Proline®

elec. sing. chan 0.2-10µl

Jencons Sealpette®

elec. sing. chan 0.2-10µl

Labpette™ .1-2µl

.5-10µl

Pipetman®

P-2 0.1-2µl

P-10 0.5-10µl

Nichiryo 0.5-10µl

Oxford-Benchmate® 0.5-10µl

Ultra Micro "Nano Tip"



2.5µl Reference mark

Product No.	Package Type	Qty/Unit	Qty/Case	Price/Unit
F101-96RS-5	96 Tip Rack - S	960	4,800	
F101-S-5	Single Wrap - S	100	1,000	
FA101-96R-5	96 Tip Rack - Autoclavable	960	4,800	
FA101-5	Bagged - Autoclavable	1,000	5,000	

Max. Capacity 10µl

For use with but not limited to:

Pipetman®

P-2 0.1-2µl

P-10 0.5-10µl

Biohit Proline®

elec. sing. chan 0.2-10µl

Eppendorf® Ref. and Res.

0.5-10µl

Jencons Sealpette®

elec. sing. chan 0.2-10µl

Labpette™ 0.1-2µl

0.5-10µl

Nichiryo 0.5-10µl

Oxford-Benchmate® 0.5-10µl

Rainin R-2 0.1-2µl

R-10 0.5-10µl

Socorex® 852 1-10µl

Ultra Micro Tip



2.5µl Reference mark

Product No.	Package Type	Qty/Unit	Qty/Case	Price/Unit
FH102-96RS-10	H 96 Tip Rack - S	960	4,800	
F102-S-10	Single Wrap - S	100	1,000	
FAH102-96R-10	H 96 Tip Rack - Autoclavable	960	4,800	
F102-10	Bagged - Autoclavable	1000	5,000	

Max. Capacity 10µl

For use with but not limited to:

Pipetman®

P-2 0.1-2µl

P-10 0.5-10µl

Biohit Proline®

elec. sing. chan 0.2-10µl

Eppendorf® Ref. and Res.

0.1-2.5µl

0.5-10µl

Jencons Sealpette®

elec. sing. chan 0.2-10µl

Labpette™ 0.1-2µl

0.5-10µl

Nichiryo 0.5-10µl

Oxford-Benchmate® 0.5-10µl

Ultra Micro Gel Loading Tip



Product No.	Package Type	Qty/Unit	Qty/Case	Price/Unit
F103-R204S-10	204 Tip Rack - S	1,020	5,100	
F103-S-10	Single Wrap - S	100	1,000	

30

w - with
w/o - without

H - Hinged
S - Sterile

* - may be purchased by the unit

First-Class Filter Tips

Max. Capacity 10µl

For use with but not limited to:

Pipetman®

- P-2 0.1-2µl
- P-10 0.5-10µl

Biohit Proline®

- elec. sing. chan. 0.2-10µl

Eppendorf® Ref. and Res. 0.5-10µl

Jencons Sealpette®

- elec. sing. chan. 0.2-10µl
- multi chan. 0.5-10µl

Labpette™, 8 & 12 Channel

Nichiryo 0.5-10µl

Oxford-Benchmate® 0.5-10µl

Ultra Micro Tip

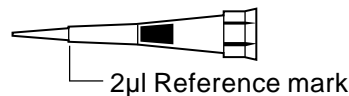

Product No.	Package Type	Qty/ Unit	Qty/ Case	Price/ Unit
F104-96RS-10	96 Tip Rack - S	960	4,800	
F104-S-10	Single Wrap - S	100	1,000	
FA104-96R-10	96 Tip Rack - Autoclavable	960	4,800	
FA104-10	Bagged - Autoclavable	1,000	5,000	

Max. Capacity 10µl

For use with but not limited to:

Titertek® 0.5-10µl

Biohit Proline®

- man. sing. chan. 0.5-10µl

Eppendorf® 5µl

Finnpipette® 0.5-10µl

Jencons Sealpette®

- man. sing. chan. 0.5-10µl

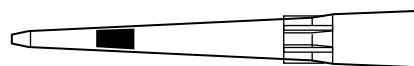

Product No.	Package Type	Qty/ Unit	Qty/ Case	Price/ Unit
F106-96RS-10	96 Tip Rack - S	960	4,800	
F106-S-10	Single Wrap - S	100	1,000	
FA106-96R-10	96 Tip Rack - Autoclavable	960	4,800	
FA106-10	Bagged - Autoclavable	1,000	5,000	

Max. Capacity 10µl

For use with but not limited to:

Titertek® 0.5-10µl

Biohit Proline®

- man. sing. chan. 0.5-10µl

Finnpipette® 0.5-10µl

Jencons Sealpette®

- man. sing. chan. 0.5-10µl

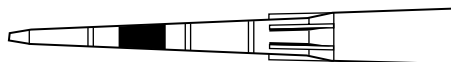

Product No.	Package Type	Qty/ Unit	Qty/ Case	Price/ Unit
F108-96RS-10	96 Tip Rack - S	960	4,800	
F108-S-10	Single Wrap - S	100	1,000	
FA108-96R-10	96 Tip Rack - Autoclavable	960	4,800	
FA108-10	Bagged - Autoclavable	1,000	5,000	

Pipet Tips

1

First-Class Filter Tips

Max. Capacity 100µl

For use with but not limited to:

Titertek®/Labsystems

multi. chan. 5-50µl

Biohit Proline®

man. sing. chan. 5-50µl

Costar® Onepette, 10-100µl

Jencons Sealpette®

man. sing. chan. 5-50µl

Labpette™, 8 & 12 Channel

Oxford-Benchmate®

10-50µl

multi. chan. 5-50µl

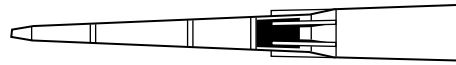

Product No.	Package Type	Qty/ Unit	Qty/ Case	Price/ Unit
F108-96RS-100	96 Tip Rack - S	960	4,800	
F108-S-100	Single Wrap - S	100	1,000	
FA108-96R-100	96 Tip Rack - Autoclavable	960	4,800	
FA108-100	Bagged - Autoclavable	1,000	5,000	

Max. Capacity 200µl

For use with but not limited to:

Biohit Proline®

man. sing. chan. 50-200µl

Costar® Onepette, 8 & 12 Pette®

20-200µl

Finnpipette® 40-200µl

Jencons Sealpette®

man. sing. chan. 50-200µl

Labpette™, 8 & 12 Channel

Oxford-Benchmate®

40-200µl

multi. chan. 40-200µl

Pipetman® P-200 50-200µl

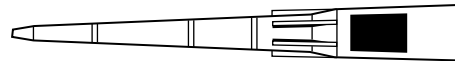

Product No.	Package Type	Qty/ Unit	Qty/ Case	Price/ Unit
F108-96RS-200	96 Tip Rack - S	960	4,800	
F108-S-200	Single Wrap - S	100	1,000	
FA108-96R-200	96 Tip Rack - Autoclavable	960	4,800	
FA108-200	Bagged - Autoclavable	1,000	5,000	

Max. Capacity 300µl

For use with but not limited to:

Titertek® 40-200µl, 50-300µl

Biohit Proline®

man. sing. chan. 50-200µl

elec. sing. chan. 10-250µl

Costar® Onepette, 8 & 12 Pette®

20-200µl

Eppendorf® Ref. and Res. 20-200µl

Finnpipette® 40-200µl, 50-300µl

Jencons Sealpette®

man. sing. chan. 50-200µl

elec. sing. chan. 10-250µl

Nichiryo 40-200µl

Oxford-Benchmate® 40-200µl

Pipetman® P-200 50-200µl

Sara-Pette® 25-250µl

Socorex 822 20-200µl

821, 851, 853 50-200µl,

Socorex Calibra 20-200µl

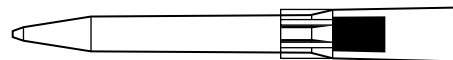

Product No.	Package Type	Qty/ Unit	Qty/ Case	Price/ Unit
F109-96RS-300	96 Tip Rack - S	960	4,800	
F109-S-300	Single Wrap - S	100	1,000	
FA109-96R-300	96 Tip Rack - Autoclavable	960	4,800	
FA109-300	Bagged - Autoclavable	1,000	5,000	

32

w - with
w/o - without

H - Hinged
S - Sterile

* - may be purchased by the unit

First-Class Filter Tips

Extra Long Tip *to ensure maximum sampling*

Max. Capacity 200µl

For use with but not limited to:

Pipetman®

P-100 10-100µl

P-200 50-200µl

Biohit Proline®

man. sing. chan. 5-50µl & 50-200µl

elec. sing. chan. 5-100µl

Costar® Onepette

10-100µl, 20-200µl

Eppendorf® 10-100µl, 20-200µl

Finnpipette® 5-40µl, 40-200µl

Jencons Sealpette®

man. sing. chan. 5-50µl & 50-200µl

elec. sing. chan. 5-100µl

Labpette™ 10-100µl

20-200µl

MLA™ 100µl

Nichiryo 40-200µl

Oxford-Benchmate® 40-200µl

Socorex

811, 822 10-100µl

821, 822 20-200µl

Titertek® 5-40µl, 40-200µl

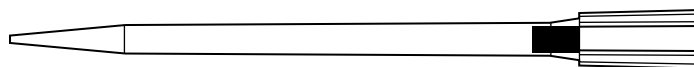

Product No.	Package Type	Qty/ Unit	Qty/ Case	Price/ Unit
F110-NXL-R204S-200	204 Tip Rack - S	1,632	4,896	
F110-NXL-S-200	Single Wrap - S	100	1,000	
FA110-NXL-R204-200	204 Tip Rack - Autoclavable	1,632	4,896	
FA110-NXL-200	Bagged - Autoclavable	1,000	5,000	

Max. Capacity 1000µl

For use with but not limited to:

Pipetman® P-1000, 100-1000µl

Biohit Proline®

elec. sing. chan. 50-1000µl

man. sing. chan. 200-1000µl

Costar® Onepette 100-1000µl

Eppendorf®

100-1000µl

200-1000µl

Finnpipette® 200-1000µl

Jencons Sealpette®

elec. sing. chan. 50-1000µl

man. sing. chan. 200-1000µl

Nichiryo 200-1000µl

Oxford-Benchmate® 200-1000µl

SMI Airpettor 200-1000µl

Socorex

811 1000µl

821 200-1000µl

822 100-1000µl

Titertek® 200-1000µl

Extra Long Tip *to ensure maximum sampling*

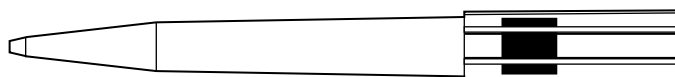

Product No.	Package Type	Qty/ Unit	Qty/ Case	Price/ Unit
F111-NXL-R100S-1000	100 Tip Rack - S	1,000	5,000	
F111-NXL-S-1000	Single Wrap - S	100	1,000	
FA111-NXL-R100-1000	100 Tip Rack - Autoclavable	1,000	5,000	
FA111-NXL-1000	Bagged - Autoclavable	1,000	5,000	

Pipet Tips

1

First-Class Filter Tips

Max. Capacity 20µl

For use with but not limited to:

Pipetman® P-20 2-20µl
 Costar® Onepette 1-20µl
 Eppendorf® 2-20µl
 Labpette™ 10-100µl
 MLA® 20µl
 Socorex
 822 2-20µl,
 821, 851, 853 5-50µl
 822 10-100µl
 Socorex Calibra 10-100µl



Product No.	Package Type	Qty/ Unit	Qty/ Case	Price/ Unit
F113-96RNS-20	96 Tip Rack - S	960	4,800	
F113-NS-20	Single Wrap - S	100	1,000	
FA113-96RN-20	96 Tip Rack - Autoclavable	960	4,800	
FA113-N-20	Bagged - Autoclavable	1,000	5,000	

Max. Capacity 50µl

For use with but not limited to:

Finnpipette® 5-40µl, 5-50µl
 Titertek® 5-40µl, 5-50µl
 Biohit Proline®
 man. sing. chan. 5-50µl
 Jencons Sealpette®
 man. sing. chan. 5-50µl
 Labpette™ 10-100µl
 20-200µl
 Nichiryo 10-50µl
 Oxford-Benchmate® 10-50µl



Product No.	Package Type	Qty/ Unit	Qty/ Case	Price/ Unit
F113-96RNS-50	96 Tip Rack - S	960	4,800	
F113-NS-50	Single Wrap - S	100	1,000	
FA113-96RN-50	96 Tip Rack - Autoclavable	960	4,800	
FA113-N-50	Bagged - Autoclavable	1,000	5,000	

Max. Capacity 100µl

For use with but not limited to:

Biohit Proline®
 sing. chan. elec. 5-100µl
 Eppendorf® 10-100µl
 Finnpipette® 5-40µl
 Jencons Sealpette®
 sing. chan. elec. 5-100µl
 Labpette™ (MC) 20-200µl
 MLA® 100µl
 Oxford-Benchmate® 40-200µl



Product No.	Package Type	Qty/ Unit	Qty/ Case	Price/ Unit
F113-96RNS-100	96 Tip Rack - S	960	4,800	
F113-NS-100	Single Wrap - S	100	1,000	
FA113-96RN-100	96 Tip Rack - Autoclavable	960	4,800	
FA113-N-100	Bagged - Autoclavable	1,000	5,000	

Max. Capacity 150µl

For use with but not limited to:

Pipetman® P-200 50-200µl
 Biohit Proline®
 man. sing. chan. 50-200µl
 Finnpipette®, 40-200µl, 50-300µl
 Jencons Sealpette®
 man. sing. chan. 50-200µl
 Labpette™ (MC) 20-200µl
 Titertek® 40-200µl, 50-300µl

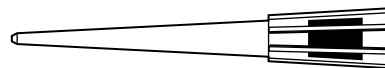

Product No.	Package Type	Qty/ Unit	Qty/ Case	Price/ Unit
F113-96RNS-150	96 Tip Rack - S	960	4,800	
F113-NS-150	Single Wrap - S	100	1,000	
FA113-96RN-150	96 Tip Rack - Autoclavable	960	4,800	
FA113-N-150	Bagged - Autoclavable	1,000	5,000	

First-Class Filter Tips

Max. Capacity 10µl

For use with but not limited to:

Eppendorf® 0.5-10µl
 Nichiryo 0.5-10µl
 Oxford-Benchmate® 0.5-10µl
 Socorex
 811 5µl
 822 0.4-2µl, 1-10µl

Ultra Micro Tip

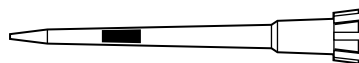

Product No.	Package Type	Qty/ Unit	Qty/ Case	Price/ Unit
F114-R100S-10	100 Tip Rack - S	1,000	5,000	
F114-S-10	Single Wrap - S	100	1,000	
FA114-R100-10	100 Tip Rack - Autoclavable	1,000	5,000	
FA114-10	Bagged - Autoclavable	1,000	5,000	

Max. Capacity 20µl

For use with but not limited to:

Pipetman® P-20 2-20µl
 (Requires adaptor-
 included with tips)

Ultra Micro Tip

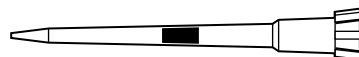

Product No.	Package Type	Qty/ Unit	Qty/ Case	Price/ Unit
F114-R100S-20	100 Tip Rack - S	1,000	5,000	
F114-S-20	Single Wrap - S	100	1,000	
FA114-R100-20	100 Tip Rack - Autoclavable	1,000	5,000	
FA114-20	Bagged - Autoclavable	1,000	5,000	

Max. Capacity 100µl

For use with but not limited to:

Eppendorf® 10-100µl
 Model 4850-Electronic
 Model 5221-EDOS™
 Model 4810-Adjus. Vol.
 Model 4800-Fixed Vol.
 Model 3190-Stnd. Fixed Vol.
 Model 4703-Tri-Vol.
 Model 2000 (Ref. & Res.)
 Model 2100 (Ref. & Res.)

Biohit Proline®
 sing. chan. elec. 5-100µl

Jencons Sealpette®
 sing. chan. elec. 5-100µl

MLA® 100µl

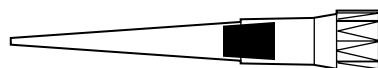

Product No.	Package Type	Qty/ Unit	Qty/ Case	Price/ Unit
F115-96RNS-100	96 Tip Rack - S	960	4,800	
F115-NS-100	Single Wrap - S	100	1,000	
FA115-96RN-100	96 Tip Rack - Autoclavable	960	4,800	
FA115-N-100	Bagged - Autoclavable	1,000	5,000	

Max. Capacity 200µl

For use with but not limited to:

Eppendorf® 10-100µl
 Finnpiquette® 40-200µl
 MLA® 100µl

Extra Long Tip to ensure maximum sampling

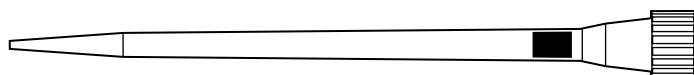

Product No.	Package Type	Qty/ Unit	Qty/ Case	Price/ Unit
F115-NXL-R100S-200	100 Tip Rack - S	800	4,000	
F115-NXL-S-200	Single Wrap - S	100	1,000	
FA115-NXL-R100-200	100 Tip Rack - Autoclavable	800	4,000	
FA115-NXL-200	Bagged - Autoclavable	1,000	5,000	

Pipet Tips

1

First-Class Filter Tips

Max. Capacity 350µl

For use with but not limited to:

Eppendorf® 350µl
 Model 4850-Electronic
 Model 5221-EDOS™
 Labpette™ 100-1000µl



Product No.	Package Type	Qty/ Unit	Qty/ Case	Price/ Unit
F116-R100NS-350	100 Tip Rack - S	1,000	5,000	
F116-NS-350	Single Wrap - S	100	1,000	
FA116-R100N-350	100 Tip Rack - Autoclavable	1,000	5,000	
FA116-N-350	Bagged - Autoclavable	1,000	5,000	

Max. Capacity 500µl

For use with but not limited to:

Eppendorf® 500µl
 Biohit Proline®
 elec. sing. chan. 20-500µl
 Jencons Sealpette®
 elec. sing. chan. 20-500µl
 Labpette™ 100-1000µl

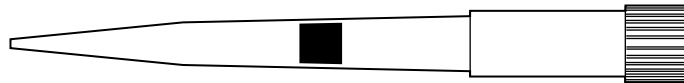

Product No.	Package Type	Qty/ Unit	Qty/ Case	Price/ Unit
F116-NXL-R100S-500	100 Tip Rack - S	1,000	5,000	
F116-NXL-S-500	Single Wrap - S	100	1,000	

Max. Capacity 1000µl

For use with but not limited to:

Eppendorf® 100-1000µl
 Biohit Proline®
 Man. Sing. Chan. 200-1000µl
 Elec. Sing. Chan. 50-1000µl
 FinnpiPETTE® 200-1000µl
 Jencons Sealpette®
 Man. Sing. Chan. 200-1000µl
 Elec. Sing. Chan. 50-1000µl
 Labpette™ 100-1000µl
 Nichiryo 200-1000µl
 Oxford-Benchmate® 200-1000µl
 SMI Airpette® 200-1000µl
 Socorex 811 1000µl
 821 200-1000µl
 822 100-1000µl

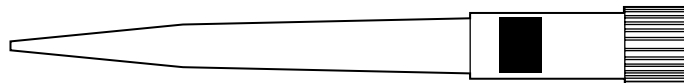

Product No.	Package Type	Qty/ Unit	Qty/ Case	Price/ Unit
F116-NXL-R100S-1000	100 Tip Rack - S	1,000	5,000	
F116-NXL-S-1000	Single Wrap - S	100	1,000	

Max. Capacity 100µl

For use with but not limited to:

Biohit Proline®
 man. sing. chan. 5-50µl
 elec. sing. chan. 5-100µl
 man. multi. chan. 5-50µl
 Jencons Sealpette®
 man. sing. chan. 5-50µl
 elec. sing. chan. 5-100µl
 man. multi. chan. 5-50µl

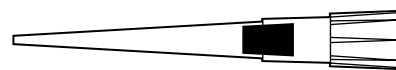

Product No.	Package Type	Qty/ Unit	Qty/ Case	Price/ Unit
F117-96RNS-100	96 Tip Rack - S	960	4,800	
F117-NS-100	Single Wrap - S	100	1,000	
FA117-96RN-100	96 Tip Rack - Autoclavable	960	4,800	
FA117-N-100	Bagged - Autoclavable	1,000	5,000	

36

w - with
 w/o - without

H - Hinged
 S - Sterile

* - may be purchased by the unit

First-Class Filter Tips

Max. Capacity 200µl

For use with but not limited to:

Biohit Proline®

- elec. sing. chan. 10-250µl
- elec. multi. chan. 25-250µl
- man. sing. chan. 50-200µl

Jencons Sealpette®

- elec. sing. chan. 10-250µl
- elec. multi. chan. 25-250µl
- man. sing. chan. 50-200µl



Product No.	Package Type	Qty/ Unit	Qty/ Case	Price/ Unit
F117-96RNS-200	96 Tip Rack - S	960	4,800	
F117-NS-200	Single Wrap - S	100	1,000	
FA117-96RN-200	96 Tip Rack - Autoclavable	960	4,800	
FA117-N-200	Bagged - Autoclavable	1,000	5,000	

Max. Capacity 300µl

For use with but not limited to:

Biohit Proline®

- man. multi. chan. 50-250µl
- man. multi. chan. 50-300µl
- elec. sing. chan. 10-250µl
- elec. multi. chan. 25-250µl

Jencons Sealpette®

- man. multi. chan. 50-250 µl
- man. multi. chan. 50-300µl
- elec. sing. chan. 10-250µl
- elec. multi. chan. 25-250µl

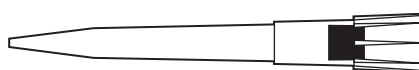

Product No.	Package Type	Qty/ Unit	Qty/ Case	Price/ Unit
F117-NXL-96RNS-300	96 Tip Rack - S	960	4,800	
F117-NXL-S-300	Single Wrap - S	100	1,000	
FA117-NXL-96R-300	96 Tip Rack - Autoclavable	960	4,800	
FA117-NXL-300	Bagged - Autoclavable	1,000	5,000	

Large Orifice Tip

Max. Capacity 200µl

For use with but not limited to:

Pipetman® P-200 50-200µl

Biohit Proline® 50-200µl

Costar® Onepette, 8 & 12 Pette®

Eppendorf® Ref. & Res. 20-200µl

Finnpipette® 40-200µl

Jencons Sealpette® 50-200µl

Labpette™ (MC) 20-200µl

MLA™ 100µl

Nichiryo 40-200µl

Oxford-Benchmate® 40-200µl

Titertek® 40-200µl

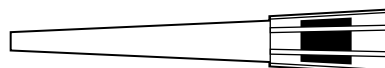

Product No.	Package Type	Qty/ Unit	Qty/ Case	Price/ Unit
F118-96RNS-200	96 Tip Rack - S	960	4,800	
F118-NS-200	Single Wrap - S	100	1,000	
FA118-96RN-200	96 Tip Rack - Autoclavable	960	4,800	
FA118-N-200	Bagged - Autoclavable	1,000	5,000	

Pipet Tips

1

First-Class Filter Tips

Large Orifice Extra Long Tip *to ensure maximum sampling*

Max. Capacity 1000µl

For use with but not limited to:

Pipetman® P-1000 100-1000µl
Biohit Proline®

man. sing. chan. 200-1000µl

elec. sing. chan. 50-1000µl

Costar® Onepette 100-1000µl

Eppendorf® 100-1000µl

Finnpipette® 200-1000µl

Jencons Sealpette®

man. sing. chan. 200-1000µl

elec. sing. chan. 50-1000µl

Nichiryo 200-1000µl

Oxford-Benchmate® 200-1000µl

SMI Airpettor 200-1000µl

Socorex 811, 821, 822 200-1000µl

Titertek® 200-1000µl

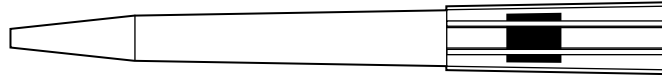

Product No.	Package Type	Qty/ Unit	Qty/ Case	Price/ Unit
F119-NXL-R100S-1000	100 Tip Rack - S	1,000	5,000	
F119-NXL-S-1000	Single Wrap - S	100	1,000	
FA119-NXL-R100-1000	100 Tip Rack - Autoclavable	1,000	5,000	
FA119-NXL-1000	Bagged - Autoclavable	1,000	5,000	

Max. Capacity 1250µl

For use with but not limited to:

Matrix

Multi 8

Multi 12



Product No.	Package Type	Qty/ Unit	Qty/ Case	Price/ Unit
F122-96RS-1250	96 Tip Rack - S	960	4,800	
F122-S-1250	Single Wrap - S	100	1,000	
FA122-96R-1250	96 Tip Rack - Autoclavable	960	4,800	
FA122-1250	Bagged - Autoclavable	1,000	5,000	

Ultra Micro Gel Loading Tip

Max. Capacity 10µl

For use with but not limited to:

Eppendorf® 0.5-10µl

Nichiryo 0.5-10µl

Oxford-Benchmate® 0.5-10µl

Socorex 811 5µl

822 0.4µl & 1-10µl

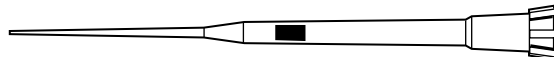

Product No.	Package Type	Qty/ Unit	Qty/ Case	Price/ Unit
F123-R204S-10	204 Tip Rack - S	1,632	4,896	
F123-S-10	Single Wrap - S	100	1,000	

Max. Capacity 1200µl

For use with but not limited to:

Biohit Proline®

elec. multi. chan. 50-1200µl

Jencons Sealpette®

elec. multi. chan. 50-1200µl

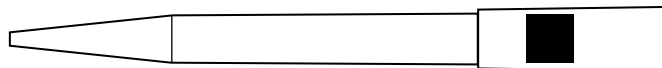

Product No.	Package Type	Qty/ Unit	Qty/ Case	Price/ Unit
F126-96RS-1200	96 Tip Rack - S	960	4,800	
F126-S-1200	Single Wrap - S	100	1,000	
FA126-96R-1200	96 Tip Rack - Autoclavable	960	4,800	
FA126-1200	Bagged - Autoclavable	1,000	5,000	

First-Class Filter Tips

Max. Capacity 300µl

For use with but not limited to:

Biohit Proline®

man. sing. chan. 50-200µl

man. multi. chan. 50-250µl

man. multi. chan. 50-300µl

elec. sing. chan. 10-250µl

elec. multi. chan. 25-250µl

Costar® Onepette, 8 & 12 Pette®

Eppendorf® Ref. 50-200µl

Eppendorf® Res. 10-200µl

Finnpipette® 40-200µl, 50-300µl

Jencons Sealpette®

man. sing. chan. 50-200µl

man. multi. chan. 50-250µl

man. multi. chan. 50-300µl

elec. sing. chan. 10-250µl

elec. multi. chan. 25-250µl

Pipetman® P-200 50-200µl

Rainin R-200 50-200µl

Titertek® 40-200µl, 50-300µl

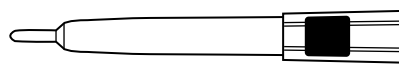

Product No.	Color	Package Type	Qty/ Unit	Qty/ Case	Price/ Unit
F169-96RS-300	Natural	96 Tip Rack-S	960	4,800	
F169-S-300	Natural	Single Wrap-S	100	1,000	

Note: The base (large end) of the tip is designed to accommodate the difference between the ejector mechanism's of the single and multi-channel Biohit pipettors, providing a perfect fit on both.

Max. Capacity 100µl

For use with but not limited to:

Socorex 811 100µl

821 50-200µl

822 10-100µl, 20-200µl

851 50-200µl

853 50-200µl

Socorex Calibra 10-100µl, 20-200µl

Biohit Proline®

elec. sing. chan. 5-100µl

Eppendorf® 10-100µl

Jencons Sealpette®

elec. sing. chan. 5-100µl

Labpette™ 10-100µl

20-200µl

Pipetman® P-100 10-100µl

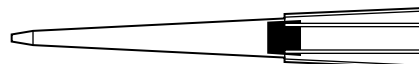

Product No.	Package Type	Qty/ Unit	Qty/ Case	Price/ Unit
F177-96RS-100	96 Tip Rack - S	960	4,800	
F177-S-100	Single Wrap - S	100	1,000	
FA177-96R-100	96 Tip Rack - Autoclavable	960	4,800	
FA177-100	Bagged - Autoclavable	1,000	5,000	

Robotic Tips

Zymark® Automation Certified® Tempo™ Pipet Tips



The QSP brand has been combined with Zymark's engineering excellence to produce the first Automation Certified tip and rack system for Zymark automated liquid handling systems.

Designed to assure reliable operation with Zymark's RapidPlate® 96 & RapidPlate® 96/384 and all Micro Assay modules and workstations, this is the **only tip and rack system recommended by Zymark®**.

• Tightly controlled manufacturing process provides uniformity from rack to rack

- Trouble free performance with Zymark® automation hardware
- Compatible with existing Zymark® Micro Assay modules

Minor modification to Easy Lab software may be necessary due to increased length of tips. If assistance is needed, call Zymark's Zyline: (508) 435-9761

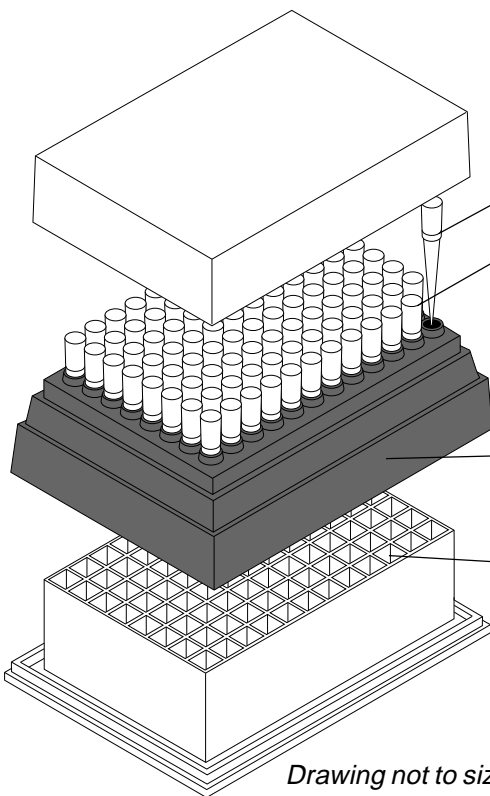

Exclusively
Manufactured
by QSP®.

- 100µl & 200µl capacity tips
- Improved attachment entry point enhances reliability of the seal, improving dispensing accuracy
- Rigid box design ensures reliable tip attachment
- Individual compartments for each tip, preventing cross-contamination

Drawing not to size

Cross Reference:	
QSP®	Zymark®
159	68037
159-96R	66670
159-96RS	68036
LMF159-96RS-80	68759
BLK-159-96R	68892
BLK-159-96RS	68924
BLK-LMF159-96RS-80	72308

Cross Reference:	
QSP®	Zymark®
160	57203
160-96R	56362
160-96RS	56977
LMF160-96RS-150	68921
BLK-160-96R	65408
BLK-160-96RS	68891
BLK-LMF160-96RS-150	72309

Volume: 100µl

Polypropylene

For use with but not limited to:

Zymark®



Product No.	Color	Package Type	Qty/ Unit	Qty/ Case	Price/ Unit
159	Natural	Bagged	1,000	10,000	
159-96R	Natural	96 Tip Rack	960	4,800	
159-96RS	Natural	96 Tip Rack - S	960	4,800	

* - may be purchased by the unit

Robotic Tips

Volume: 200µl

Polypropylene

For use with but not limited to:

Zymark®



Product No.	Color	Package Type	Qty/ Unit	Qty/ Case	Price/ Unit
160	Natural	Bagged	1,000	10,000	
160-96R	Natural	96 Tip Rack	960	4,800	
160-96RS	Natural	96 Tip Rack - S	960	4,800	

Zymark® Automation Certified® Tempo™ Filter Pipet Tips

Max Capacity: 80µl

Polypropylene

For use with but not limited to:

Zymark®

Robot compatible (large micron), hydrophobic filter effectively eliminates instrument contamination caused by aerosol formation during pipetting procedures.



Product No.	Color	Package Type	Qty/ Unit	Qty/ Case	Price/ Unit
LMF159-96RS-80	Natural	96 Tip Rack - S	960	4,800	

Max Capacity: 150µl

Polypropylene

For use with but not limited to:

Zymark®

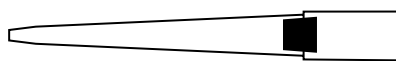

Product No.	Color	Package Type	Qty/ Unit	Qty/ Case	Price/ Unit
LMF160-96RS-150	Natural	96 Tip Rack - S	960	4,800	

Tested by an independent laboratory to ensure product is RNase, DNase and Pyrogen free.



Volume: 1000µl

For use with but not limited to:

Zymark®

Automated Liquid
Handling System

Additional Zymark® Pipet Tip

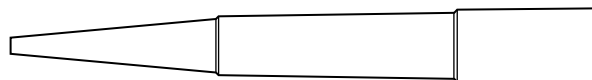

Product No.	Color	Package Type	Qty/ Unit	Qty/ Case	Price/ Unit
137	Blue	Bagged	500	5,000	
137-R100	Blue	100 Tip Rack	1,000	5,000	
137-R100S	Blue	100 Tip Rack-S	1,000	5,000	

Robotic Tips

Zymark® Automation Certified® Tempo™ Pipet Tips

Volume: 100µl

Conductive Polypropylene

For use with but not limited to:

Zymark®



Product No.	Package Type	Qty/ Unit	Qty/ Case	Price/ Unit
BLK-159-96R	96 Tip Rack	960	4,800	
BLK-159-96RS	96 Tip Rack - S	960	4,800	

Volume: 200µl

Conductive Polypropylene

For use with but not limited to:

Zymark®



Product No.	Package Type	Qty/ Unit	Qty/ Case	Price/ Unit
BLK-160-96R	96 Tip Rack	960	4,800	
BLK-160-96RS	96 Tip Rack - S	960	4,800	

Max Capacity: 80µl

Conductive Polypropylene

For use with but not limited to:

Zymark®

Filter Tip



Product No.	Package Type	Qty/ Unit	Qty/ Case	Price/ Unit
BLK-LMF159-96RS-80	96 Tip Rack - S	960	4,800	

Max Capacity: 150µl

Conductive Polypropylene

For use with but not limited to:

Zymark®

Filter Tip



Product No.	Package Type	Qty/ Unit	Qty/ Case	Price/ Unit
BLK-LMF160-96RS-150	96 Tip Rack - S	960	4,800	

Robotic Tips

For use with:

Beckman® Biomek 1000/2000

Interchangeable Liquid Handling Tools and Beckman Manual Pipetters

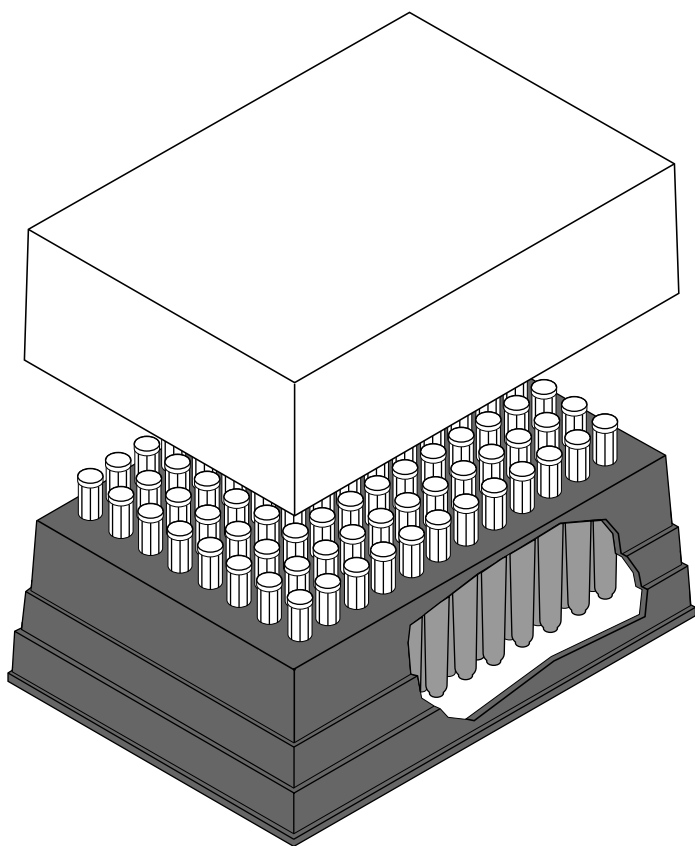

Robotic

A slight rocking motion is generally used to seat tips onto a hand held multichannel pipetter. Automated liquid handling systems rely on force, which can cause flexing in the rack and improper seating of the tips. The QSP® “robotic compatible rack” is specifically designed to withstand extreme force, ensuring reliable attachment of all 96 tips. Individual interior rack compartments isolate each tip eliminating the possibility of cross-contamination.

Tips

Manufactured of virgin, non-wettable, polypropylene material, QSP pipet tips reduce fluid retention and optimize instrument performance. Robot compatible (large micron), hydrophobic filter effectively eliminates instrument contamination caused by aerosol formation during pipetting procedures.

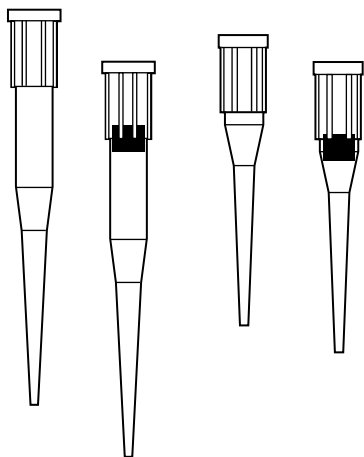

Pre-sterilized (Gamma Radiation) Certified RNase, DNase and Pyrogen free; also metal free.



Non-sterilized: Certified RNase, DNase free; also metal free.

Robotic Tips

Beckman® Biomek 1000/2000

Volume: 1-20µl

For use with but not limited to:

P20 & P200L Single-Tip Tool
MP20 & MP200 Eight-Tip Tool

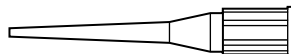

Product No.	Color	Package Type	Qty/ Unit	Qty/ Case	Price/ Unit
141	Natural	Bagged	1,000	10,000	
141-96R	Natural	96 Tip Rack	960	4,800	
141-96RS	Natural	96 Tip Rack - S	960	4,800	

Volume: 5-250µl

For use with but not limited to:

P20 & P200L Single-Tip Tool
MP20 & MP200 Eight-Tip Tool
Manual Pipetters

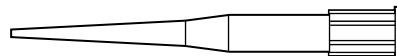

Product No.	Color	Package Type	Qty/ Unit	Qty/ Case	Price/ Unit
142	Natural	Bagged	1,000	10,000	
142-96R	Natural	96 Tip Rack	960	4,800	
142-96RS	Natural	96 Tip Rack - S	960	4,800	

Filter Tip

Max. Capacity: 20µl

For use with but not limited to:

P20 & P200L Single-Tip Tool
MP20 & MP200 Eight-Tip Tool

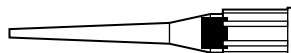

Product No.	Color	Package Type	Qty/ Unit	Qty/ Case	Price/ Unit
LMF141-96RS-20	Natural	96 Tip Rack - S	960	4,800	
LMF141-S-20	Natural	Single Wrap - S	100	1,000	

Filter Tip

Max. Capacity: 180µl

For use with but not limited to:

P20 & P200L Single-Tip Tool
MP20 & MP200 Eight-Tip Tool

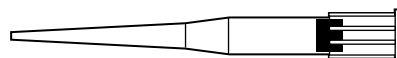

Product No.	Color	Package Type	Qty/ Unit	Qty/ Case	Price/ Unit
LMF142-96RS-180	Natural	96 Tip Rack - S	960	4,800	
LMF142-S-180	Natural	Single Wrap - S	100	1,000	

Robotic Tips

Beckman® Biomek 1000/2000 & Packard MultiPROBE™

Volume: 20µl

For use with but not limited to:

Packard MultiPROBE™

Beckman Biomek® 1000/2000



Product No.	Package Type	Qty/ Unit	Qty/ Case	Price/ Unit
BLK-141-96R	96 Tip Rack	960	4,800	
BLK-141-96RS	96 Tip Rack - S	960	4,800	

Volume: 250µl

For use with but not limited to:

Packard MultiPROBE™

Beckman Biomek® 1000/2000



Product No.	Package Type	Qty/ Unit	Qty/ Case	Price/ Unit
BLK-142-96R	96 Tip Rack	960	4,800	
BLK-142-96RS	96 Tip Rack - S	960	4,800	

Max. Capacity 20µl

For use with but not limited to:

Packard MultiPROBE™

Beckman Biomek® 1000/2000

Filter Tip



Product No.	Package Type	Qty/ Unit	Qty/ Case	Price/ Unit
BLK-LMF141-96RS-20	96 Tip Rack - S	960	4,800	

Max. Capacity 180µl

For use with but not limited to:

Packard MultiPROBE™

Beckman Biomek® 1000/2000

Filter Tip



Product No.	Package Type	Qty/ Unit	Qty/ Case	Price/ Unit
BLK-LMF142-96RS-180	96 Tip Rack - S	960	4,800	

Volume: 1000µl

For use with but not limited to:

Packard MultiPROBE™



Product No.	Package Type	Qty/ Unit	Qty/ Case	Price/ Unit
BLK-111-R100	100 Tip Rack	1,000	5,000	
BLK-111-R100S	100 Tip Rack - S	1,000	5,000	

Robotic Tips

Tecan Automation Pipet Tips

Volume: 20µl

For use with but not limited to:

Tecan Genesis



Product No.	Color	Package Type	Qty/ Unit	Qty/ Case	Price/ Unit
171	Natural	Bagged	1,000	10,000	
171-96R	Natural	96 Tip Rack	960	4,800	
171-96RS	Natural	96 Tip Rack - S	960	4,800	

Volume: 50µl

For use with but not limited to:

Tecan Genesis



Product No.	Color	Package Type	Qty/ Unit	Qty/ Case	Price/ Unit
172	Natural	Bagged	1,000	10,000	
172-96R	Natural	96 Tip Rack	960	4,800	
172-R96S	Natural	96 Tip Rack - S	960	4,800	

Volume: 200µl

For use with but not limited to:

Tecan Genesis

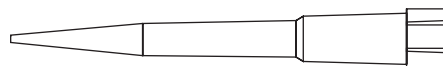

Product No.	Color	Package Type	Qty/ Unit	Qty/ Case	Price/ Unit
173	Natural	Bagged	1,000	10,000	
173-96R	Natural	96 Tip Rack	960	4,800	
173-96RS	Natural	96 Tip Rack - S	960	4,800	

Volume: 1000µl

For use with but not limited to:

Tecan Genesis



Product No.	Color	Package Type	Qty/ Unit	Qty/ Case	Price/ Unit
175	Natural	Bagged	1,000	10,000	
175-96R	Natural	96 Tip Rack	960	4,800	
175-96RS	Natural	96 Tip Rack - S	960	4,800	

Robotic Tips

Tecan Automation Pipet Tips

Filter Tip

Max Capacity: 10µl

For use with but not limited to:

Tecan Genesis



Product No.	Color	Package Type	Qty/ Unit	Qty/ Case	Price/ Unit
LMF171-96RS-10	Natural	96 Tip Rack - S	960	4,800	

Max Capacity: 50µl

For use with but not limited to:

Tecan Genesis

Filter Tip

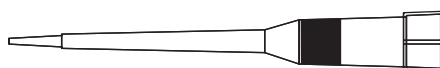

Product No.	Color	Package Type	Qty/ Unit	Qty/ Case	Price/ Unit
LMF172-R96S-50	Natural	96 Tip Rack - S	960	4,800	

Max Capacity: 200µl

For use with but not limited to:

Tecan Genesis

Filter Tip

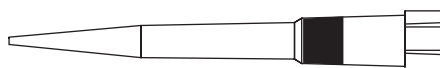

Product No.	Color	Package Type	Qty/ Unit	Qty/ Case	Price/ Unit
LMF173-96RS-200	Natural	96 Tip Rack - S	960	4,800	

Max Capacity: 1000µl

For use with but not limited to:

Tecan Genesis

Filter Tip

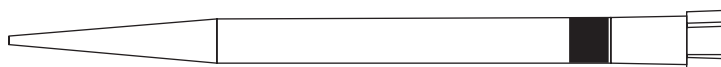

Product No.	Color	Package Type	Qty/ Unit	Qty/ Case	Price/ Unit
LMF175-96RS-1000	Natural	96 Tip Rack - S	960	4,800	

Pipet Tips

1

Robotic Tips

Tecan Automation Pipet Tips

Volume: 20µl

For use with but not limited to:

Tecan Genesis



Product No.	Package Type	Qty/ Unit	Qty/ Case	Price/ Unit
BLK-171-96R	96 Tip Rack	960	4,800	
BLK-171-96RS	96 Tip Rack - S	960	4,800	

Volume: 50µl

For use with but not limited to:

Tecan Genesis



Product No.	Package Type	Qty/ Unit	Qty/ Case	Price/ Unit
BLK-172-96R	96 Tip Rack	960	4,800	
BLK-172-R96S	96 Tip Rack - S	960	4,800	

Volume: 200µl

For use with but not limited to:

Tecan Genesis



Product No.	Package Type	Qty/ Unit	Qty/ Case	Price/ Unit
BLK-173-96R	96 Tip Rack	960	4,800	
BLK-173-96RS	96 Tip Rack - S	960	4,800	

Volume: 1000µl

For use with but not limited to:

Tecan Genesis



Product No.	Package Type	Qty/ Unit	Qty/ Case	Price/ Unit
BLK-175-96R	96 Tip Rack	960	4,800	
BLK-175-96RS	96 Tip Rack - S	960	4,800	

Robotic Tips

Tecan Automation Pipet Tips

Filter Tip

Max Capacity: 10 μ l

For use with but not limited to:

Tecan Genesis



Product No.	Package Type	Qty/ Unit	Qty/ Case	Price/ Unit
BLK-LMF171-96RS-10	96 Tip Rack - S	960	4,800	

Max Capacity: 50 μ l

For use with but not limited to:

Tecan Genesis

Filter Tip



Product No.	Package Type	Qty/ Unit	Qty/ Case	Price/ Unit
BLK-LMF172-R96S-50	96 Tip Rack - S	960	4,800	

Max Capacity: 200 μ l

For use with but not limited to:

Tecan Genesis

Filter Tip



Product No.	Package Type	Qty/ Unit	Qty/ Case	Price/ Unit
BLK-LMF173-96RS-200	96 Tip Rack - S	960	4,800	

Max Capacity: 1000 μ l

For use with but not limited to:

Tecan Genesis

Filter Tip



Product No.	Package Type	Qty/ Unit	Qty/ Case	Price/ Unit
BLK-LMF175-96RS-1000	96 Tip Rack - S	960	4,800	

Pipet Tips

1

Robotic Tips

Qiagen Automation Pipet Tips

Volume: 300µl

For use with but not limited to:

Qiagen

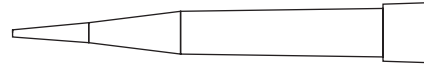

Product No.	Color	Package Type	Qty/ Unit	Qty/ Case	Price/ Unit
180	Natural	Bagged	1,000	10,000	
180-96R	Natural	96 Tip Rack	960	4,800	
180-96RS	Natural	96 Tip Rack - S	960	4,800	

Volume: 1100µl

For use with but not limited to:

Qiagen

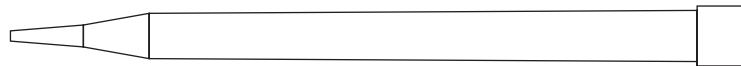

Product No.	Color	Package Type	Qty/ Unit	Qty/ Case	Price/ Unit
181	Natural	Bagged	1,000	10,000	
181-96R	Natural	96 Tip Rack	960	4,800	
181-96RS	Natural	96 Tip Rack - S	960	4,800	

Max Capacity: 300µl

For use with but not limited to:

Qiagen

Filter Tip

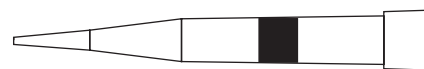

Product No.	Color	Package Type	Qty/ Unit	Qty/ Case	Price/ Unit
LMF180-96RS-300	Natural	96 Tip Rack - S	960	4,800	

Max Capacity: 1100µl

For use with but not limited to:

Qiagen

Filter Tip

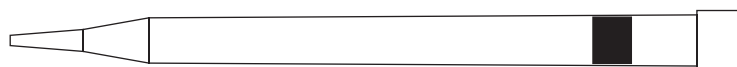

Product No.	Color	Package Type	Qty/ Unit	Qty/ Case	Price/ Unit
LMF181-96RS-1100	Natural	96 Tip Rack - S	960	4,800	

50

w - with
w/o - without

H - Hinged
S - Sterile

* - may be purchased by the unit

Robotic Tips

Qiagen Automation Pipet Tips

Volume: 300µl

For use with but not limited to:

Qiagen



Product No.	Package Type	Qty/ Unit	Qty/ Case	Price/ Unit
BLK-180-96R	96 Tip Rack	960	4,800	
BLK-180-96RS	96 Tip Rack - S	960	4,800	

Volume: 1100µl

For use with but not limited to:

Qiagen



Product No.	Package Type	Qty/ Unit	Qty/ Case	Price/ Unit
BLK-181-96R	96 Tip Rack	960	4,800	
BLK-181-96RS	96 Tip Rack - S	960	4,800	

Filter Tip

Max Capacity: 300µl

For use with but not limited to:

Qiagen



Product No.	Package Type	Qty/ Unit	Qty/ Case	Price/ Unit
BLK-LMF180-96RS-300	96 Tip Rack - S	960	4,800	

Filter Tip

Max Capacity: 1100µl

For use with but not limited to:

Qiagen



Product No.	Package Type	Qty/ Unit	Qty/ Case	Price/ Unit
BLK-LMF181-96RS-1100	96 Tip Rack - S	960	4,800	

Robotic Tips

Liquid-Level Sensing

Many well known automated liquid handling systems use liquid-level sensing (Black) tips.

For use with but not limited to equipment from these manufacturers:

- Tecan
- Rosys Inc.
- Hamilton Co.
- Packard Instrument Co.

We began manufacturing **Liquid-Level Sensing Tips** for a progressive automated liquid handling equipment manufacturer who was working on a new concept. Today, many well known systems are equipped to use disposable tips in addition to washable probes. Disposable tips are necessary for critical assays where zero carry-over is imperative.

Although standard polypropylene pipet tips can be used with some systems, the majority require (tips manufactured of) **carbon black-conductive polypropylene**. This highly conductive material is necessary to detect the presence or absence of sufficient liquid, in order to avoid short sampling and excessive submersion of the tip during aspiration. The QSP® Liquid-Level Sensing Tips are specifically manufactured for this purpose.

To achieve optimal fit and function with the various standard and customized automated liquid handling systems, QSP offers a wide selection of Liquid-Level Sensing Tips ranging in volumes from 10µl to 1000µl.

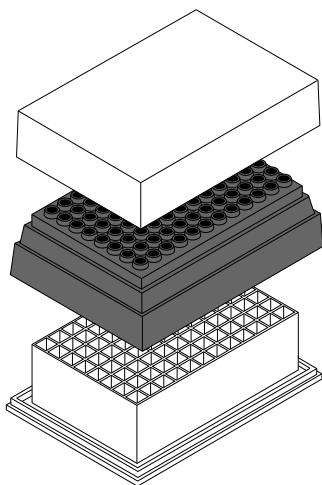

Some automated liquid handling systems require more force than ordinary pipettors to seat the tips. The additional force can cause flexing in the rack and improper seating of the tips. Our optional heavy duty rack features 96 full height individual inner compartments which provide additional stability. As an added benefit, these inner compartments serve to keep the tips separated from each other, eliminating the possibility of cross contamination.

Completed with our popular lift-off cover, the entire unit is fully autoclavable*.

* Refer to section 6 for recommended autoclaving instructions.

Volume: 0.1-10µl



Product No.	Color	Package Type	Qty/ Unit	Qty/ Case	Price/ Unit
BLK-104	Black	Bagged	1,000	10,000	
BLK-104-96R+	Black	96 Tip Rack	960	4,800	
BLK-104-96RS+	Black	96 Tip Rack - S	960	4,800	

*Available in 96 Tip Heavy Duty Compartment Rack. Please add "2" after product number and increase price \$2.00 per unit.

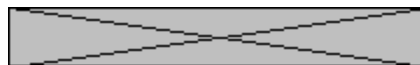
Robotic Tips**Liquid-Level Sensing****Volume: 5-300 μ l**

Product No.	Color	Package Type	Qty/ Unit	Qty/ Case	Price/ Unit
BLK-106	Black	Bagged	1,000	10,000	
BLK-106-96R⁺	Black	96 Tip Rack	960	4,800	
BLK-106-96RS⁺	Black	96 Tip Rack - S	960	4,800	

**Available in 96 Tip Heavy Duty Compartment Rack. Please add "2" after product number and increase price \$2.00 per unit.*

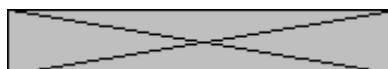
Volume: 1-200 μ l

Product No.	Color	Package Type	Qty/ Unit	Qty/ Case	Price/ Unit
BLK-110	Black	Bagged	1,000	10,000	
BLK-110-96R⁺	Black	96 Tip Rack	960	4,800	
BLK-110-96RS⁺	Black	96 Tip Rack - S	960	4,800	

**Available in 96 Tip Heavy Duty Compartment Rack. Please add "2" after product number and increase price \$2.00 per unit.*

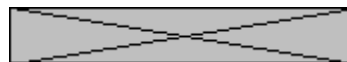
Volume: 0.5-10 μ l

Product No.	Color	Package Type	Qty/ Unit	Qty/ Case	Price/ Unit
BLK-114	Black	Bagged	1,000	10,000	
BLK-114-R100	Black	100 Tip Rack	1,000	5,000	
BLK-114-R100S	Black	100 Tip Rack - S	1,000	5,000	

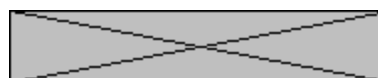
Volume: 1-200 μ l

Product No.	Color	Package Type	Qty/ Unit	Qty/ Case	Price/ Unit
BLK-115	Black	Bagged	1,000	10,000	
BLK-115-96R	Black	96 Tip Rack	960	4,800	
BLK-115-96RS	Black	96 Tip Rack - S	960	4,800	

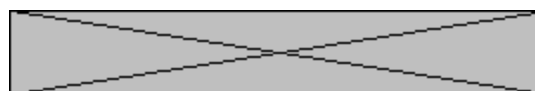
Volume: 101-1000 μ l

Product No.	Color	Package Type	Qty/ Unit	Qty/ Case	Price/ Unit
BLK-116	Black	Bagged	1,000	10,000	
BLK-116-R100	Black	100 Tip Rack	1,000	5,000	
BLK-116-R100S	Black	100 Tip Rack - S	1,000	5,000	

Robotic Tips

Heavy Duty Compartment Rack for Automated Liquid Handling Systems or Multichannel Pipetting

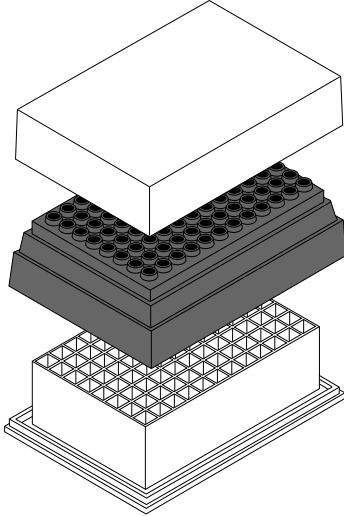

A slight rocking motion is generally used to seat the tips onto a multi-channel pipetter. Without this motion, automated liquid handling systems require more force to seat the tips. The additional force can cause flexing in the rack and improper seating of the tips. Our heavy duty rack features 96 full height individual inner compartments which provide additional stability. As an added benefit, these inner compartments serve to keep the tips separated from each other, eliminating the possibility of cross contamination. (Because of the added stability, many prefer this rack for multichannel pipetting.)

Completed with our popular lift-off cover, the entire unit is fully autoclavable*.

*Refer to section 6 for recommended autoclaving instructions.

Volume: 0.1-10 μ l

Ultra Micro "Nano Tip"

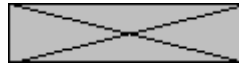

Product No.	Color	Package Type	Qty/ Unit	Qty/ Case	Price/ Unit
101-96R2	Natural	96 Tip HDC Rack	960	4,800	
101-96R2S	Natural	96 Tip HDC Rack - S	960	4,800	

Volume: 0.1-10 μ l

Ultra Micro Tip



Product No.	Color	Package Type	Qty/ Unit	Qty/ Case	Price/ Unit
104-96R2	Natural	96 Tip HDC Rack	960	4,800	
104-96R2S	Natural	96 Tip HDC Rack - S	960	4,800	

Volume: 5-200 μ l

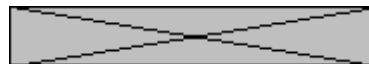

Product No.	Color	Package Type	Qty/ Unit	Qty/ Case	Price/ Unit
105-96R2	Natural	96 Tip HDC Rack	960	4,800	
105-96R2S	Natural	96 Tip HDC Rack - S	960	4,800	

Robotic Tips

Heavy Duty Compartment Rack for Automated Liquid Handling Systems or Multichannel Pipetting

Volume: 5-300 μ l

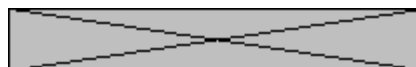

Product No.	Color	Package Type	Qty/ Unit	Qty/ Case	Price/ Unit
106-96R2	Natural	96 Tip HDC Rack	960	4,800	
106-96R2S	Natural	96 Tip HDC Rack - S	960	4,800	

Graduations at 10, 50, 100 & 200 μ l

Volume: 1-300 μ l

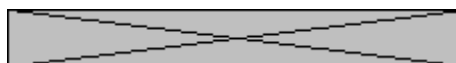

Product No.	Color	Package Type	Qty/ Unit	Qty/ Case	Price/ Unit
108-96R2G	Natural	96 Tip HDC Rack	960	4,800	
108-96R2GS	Natural	96 Tip HDC Rack - S	960	4,800	

Volume: 5-300 μ l

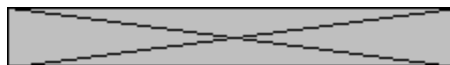

Product No.	Color	Package Type	Qty/ Unit	Qty/ Case	Price/ Unit
109-96R2	Natural	96 Tip HDC Rack	960	4,800	
109-96R2S	Natural	96 Tip HDC Rack - S	960	4,800	

Standard Yellow Tip (*Natural also available*)

Volume: 1-200 μ l

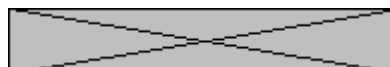

Product No.	Color	Package Type	Qty/ Unit	Qty/ Case	Price/ Unit
110-96R2	<i>Natural</i>	96 Tip HDC Rack	960	4,800	
110-96R2S	110-96R2NS	96 Tip HDC Rack - S	960	4,800	

Robotic Tips

Heavy Duty Compartment Rack for Automated Liquid Handling Systems or Multichannel Pipetting

Beveled Orifice Tip (See #113-G for Graduated version)

Volume: 1-200µl



Product No.		Package Type	Qty/ Unit	Qty/ Case	Price/ Unit
Yellow	Natural				
110-96R2B	110-96R2BN	96 Tip HDC Rack	960	4,800	
110-96R2BS	110-96R2BNS	96 Tip HDC Rack - S	960	4,800	

Thin Wall Orifice Tip

Volume: 1-250µl

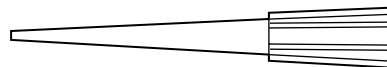

Product No.	Color	Package Type	Qty/ Unit	Qty/ Case	Price/ Unit
TW110-96R2N	Natural	96 Tip HDC Rack	960	4,800	
TW110-96R2NS	Natural	96 Tip HDC Rack - S	960	4,800	

Beveled Orifice Tip with graduations at 10, 50 & 100µl

Volume: 1-200µl

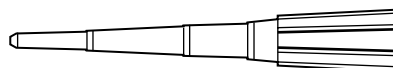

Product No.		Package Type	Qty/ Unit	Qty/ Case	Price/ Unit
Yellow	Natural				
113-96R2G	113-96R2GN	96 Tip HDC Rack	960	4,800	
113-96R2GS	113-96R2GNS	96 Tip HDC Rack - S	960	4,800	

Large Orifice Tip

Volume: 1-200µl

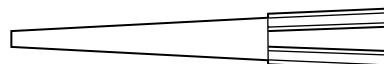

Product No.		Package Type	Qty/ Unit	Qty/ Case	Price/ Unit
Yellow	Natural				
118-96R2	118-96R2N	96 Tip HDC Rack	960	4,800	
118-96R2S	118-96R2NS	96 Tip HDC Rack - S	960	4,800	

Robotic Tips

Heavy Duty Compartment Rack for Automated Liquid Handling Systems or Multichannel Pipetting

Volume: 25-200µl

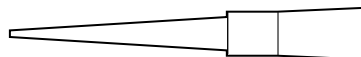

Product No.	Color	Package Type	Qty/ Unit	Qty/ Case	Price/ Unit
125-96R2	Natural	96 Tip HDC Rack	960	4,800	
125-96R2S	Natural	96 Tip HDC Rack - S	960	4,800	

Volume: 5-250µl

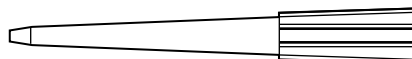

Product No.	Color	Package Type	Qty/ Unit	Qty/ Case	Price/ Unit
177-96R2	Natural	96 Tip HDC Rack	960	4,800	
177-96R2S	Natural	96 Tip HDC Rack - S	960	4,800	